

MINDEO

ES4200 Embedded Laser Barcode Scanner

User Manual



Version: ES4200_UM_EN_V1.1.7

Notice

Make sure you carefully read the following information to ensure that your barcode scanner is able to perform at the level for which it is designed.

- ☞ All software, including firmware, furnished to the user is on a licensed basis.
- ☞ The right is reserved to make changes to any software or product to improve reliability, function, or design.
- ☞ The material in this manual is subject to change without notice.
- ☞ The manufacturer assumes no responsibility for any loss or claim by third parties which may arise from the use of this manual.
- ☞ Do not throw or drop the scanner or otherwise subject it to strong impact, which can damage the scanner, interrupt program execution, corrupt memory contents, or otherwise interfere with proper operation.
- ☞ Different version of the barcode scanner may have different software function, please confirm the corresponding version of software.

Notes about structure and electric circuit design

1. Suggest using non-magnetic screws, when mounting the scanner. Magnetic screws can cause element/mirror neutral position to change.
2. It is recommended to use a thread locking method, such as a Nylok patch.
3. Do not place magnetic material (e.g. dynamic speakers, ringers, vibrators, inductors, metal parts) within 1 inch of the scanner chassis. Evaluate placement of all magnetic or ferrous material during system layout to determine if 1 inch is sufficient.
4. Leave sufficient space to accommodate the maximum size of the scanner.
5. Read section "[1-2 Electrical interface/Pin assignment](#)", carefully to learn about the electrical interface design.

Contents

Notice.....	i
Notes about structure and electric circuit design.....	ii
Contents.....	iii
1 Specifications	1
1-1 Technical specifications	1
1-2 Electrical interface/Pin assignment	2
1-3 Default settings for various types of barcode	3
1-4 Decode zone	4
2 Installation guide	6
2-1 Important notes of installation	6
2-2 Mounting	6
2-3 Appearance of the scanner	7
2-4 Scan angle	8
3 Parameter menus	9
3-1 Example: Configure scanner by scanning configuration barcodes.....	9
3-2 RS-232 interface	11
3-3 USB interface	14
3-4 Scan mode & some global settings	17
3-5 Indication.....	21
3-6 UPC-A.....	22
3-7 UPC-E.....	24
3-8 UPC-E1	26
3-9 EAN-13 (ISBN/ISSN)	28
3-10 EAN-8	30
3-11 Code 39 (Code 32, Trioptic Code 39)	32
3-12 Interleaved 2 of 5	35
3-13 Industrial 2 of 5.....	37
3-14 Matrix 2 of 5	38
3-15 Codabar	40
3-16 Code 128	42
3-17 UCC/EAN 128.....	44
3-18 ISBT 128	46
3-19 Code 93	48
3-20 Code 11	50
3-21 MSI/Plessey	52
3-22 UK/Plessey	54
3-23 China Post	56
3-24 China Finance.....	57

3-25 Telepen	60
3-26 GS1 DataBar (GS1 DataBar Truncated)	62
3-27 GS1 DataBar Limited	63
3-28 GS1 DataBar Expanded.....	64
3-29 G1-G6 & FN1 substitution string setting.....	65
3-30 G1-G4 string position & Code ID position	69
3-31 String transmission.....	70
4 Operate the scanner by command via UART or USB virtual UART.....	73
4-1 Command data packet format.....	74
4-2 CMD_ACK.....	75
4-3 CMD_NAK.....	77
4-4 DECODE_DATA	79
4-5 REQUEST_REVISION.....	80
4-6 REPLY_REVISION	81
4-7 START_DECODE	82
4-8 STOP_DECODE	83
4-9 PARAM_DEFAULTS.....	84
4-10 PARAM_REQUEST	85
4-11 PARAM_SEND.....	87
4-12 UPGRADE	90
4-13 RESTART	91
4-14 GOOD_READ_START.....	92
4-15 GOOD_READ_STOP.....	93
4-16 The control of timing conflict	94
5 Troubleshooting.....	95
6 Maintenance.....	96
7 Barcode representing non-printable character	97
8 ASCII Table.....	98
9 Test symbols	99
10 Return default parameters & firmware version	101
11 Configuration alphanumeric entry barcode	102

1 Specifications

1-1 Technical specifications

Table 1-1 Technical specifications(25°C)

Input voltage	5VDC±0.25V	
Power	356mW (operating); 740mW (peak); 105mW (sleeping)	
Current	71.2mA (operating); 148mA (peak); 21mA (sleeping)	
Laser	650nm laser diode	
Decoding rate	200times/second	
Decode capability	UPC-A, UPC-E, UPC-E1, EAN-13, EAN-8, ISBN/ISSN, Code 39, Code 39 full ASCII, Code 32, Trioptic Code 39, Interleaved 2 of 5, Industrial 2 of 5, Matrix 2 of 5, Codabar (NW7), Code 128, UCC/EAN 128, ISBT128, Code 93, Code 11(USD-8), MSI/Plessey, UK/Plessey, China Post, China Finance, Telepen, GS1 DataBar (formerly RSS) variants	
Indicator	Beeper	
Interface supported	RS-232 (3.3V TTL-level), USB, USB virtual COM	
Operating mode	Manual operation, Auto-detection, Command	
Dimensions	Height × Width × Depth: 46.2mm×41.3mm×20.7mm	
Weight	72.8g (with Zinc alloy case); 29g (with ABS case, optional)	
Case material	Zinc alloy; ABS (optional)	
Temperature	0° to 50°C (32° to 120°F), Operating; -40° to 60°C (-40° to 140°F), Storage	
Humidity	5% to 95% (non-condensing)	
Programming method	Manual (reading special barcode), Command	
Program upgrade	Online	
Decoding depth & Min. element width	(1 mil = 0.0254mm) Long-range series 5 mil: 40-110mm 10 mil: 10-280mm 13 mil: 15-315mm 16 mil: 25-385mm 35 mil: 145-630mm	High-density series 3 mil: 5-50mm 10 mil: 10-85mm 13 mil: 10-150mm 16 mil: 25-165mm 35 mil: 145-295mm
Safety	Laser safety: EN60825-1, Class 1 EMC: EN55022, EN55024 Electrical safety: EN60950-1 Protection class: IP51	

1-2 Electrical interface/Pin assignment

The scanner provides a 10 pins, 1.25mm pin-to-pin distance connector.

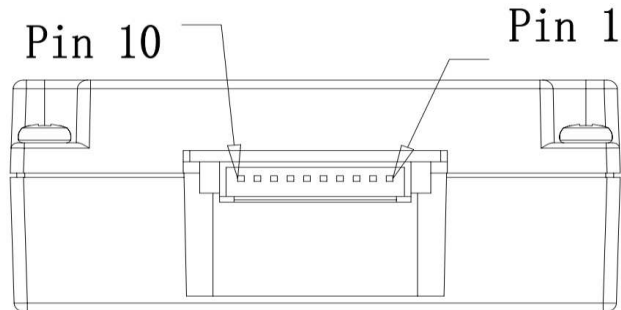

Figure 1-1 Backward view

Table 1-2 lists the pin assignments of the scanner.

Table 1-2 Electrical interface/Pin assignment

Pin No.	RS232		USB		Description
	Pin/Signal Name	Type	Pin/Signal Name	Type	
1	Power(+5V)	Input	Power(+5V)	Input	Power: +5 VDC.
2	Ground	Input	Ground	Input	Ground: 0V reference, connects to cable shields.
3	Ground	Input	Ground	Input	Ground: 0V reference.
4	+3.3V (for interface auto selection purpose)	Input	Ground (for interface auto selection purpose)	Input	RS232: Logic high level, +3.3VDC. USB: Logic low level, 0V reference.
5	TXD	Output	Reserved	-	RS232: Serial data transmit output port (Transmitted data) .
6	RXD	Input	Reserved	-	RS232: Serial data receive input port (Received data) .
7	Reserved	-	Reserved	-	Reserved.
8	TRIGGER	Input	TRIGGER	Input	Scanner trigger. Low level(activity): 0V reference. high level: 3.3VDC.
9	CTS	Input	D-	-	RS232: Serial port handshaking line (Clear-to-send) . USB: Negative differential line.
10	RTS	Output	D+	-	RS232: Serial port handshaking line (Request-to-send) . USB: Positive differential line.

Note: Voltage level of all RS232 Pin-outs (RXD, TXD, CTS and RTS) is 0V for logic low level and 3.3V for logic high level.

1-3 Default settings for various types of barcode

Table 1-3 Default settings

Code Type	Read Enable	Check Digit Verification	Check Digit Transmission	Min. Code Length	Proprietary Code ID	AIM Code ID
UPC-A	√	√	√	(12) ²	A]Em
UPC-E	√	√	√	(8) ²	D]Em
UPC-E1	√	√	√	(8) ²	D]Em
EAN-13	√	√	√	(13) ²	A]Em
EAN-8	√	√	√	(8) ²	C]Em
ISBN/ISSN ¹	√	√	√	(13) ²	B]Em
Code 39	√	-	-	1	M]Am
Interleaved 2 of 5	√	-	-	6	I]Im
Industrial 2 of 5	-	-	-	4	H]Im
Matrix 2 of 5	√	-	-	6	X]Im
Codabar	√	-	-	4	N]Fm
Code 128	√	√	-	1	K]Cm
UCC/EAN 128	√	√	-	1	K]Cm
ISBT 128	√	√	-	1	K]Cm
Code 93	√	√	-	1	L]Gm
Code 11	-	√	-	4	V	-
MSI/Plessey	-	-	-	4	O]Mm
UK/Plessey	√	√	-	1	U]Mm
China Post	√	-	-	(11) ²	T]Im
China Finance	√	-	-	(10) ²	Y	-
Telepen	√	√	-	1	P]Em
GS1 DataBar	√	-	-	(16) ²	R]em
GS1 DataBar Truncated ³	√	-	-	(16) ²	R]em
GS1 DataBar Limited	√	-	-	(16) ²	R]em
GS1 DataBar Expanded	√	-	-	1	R]em

Note: ¹The settings for ISBN/ISSN and EAN-13 must be the same except the code ID.

² Fixed-length barcodes.

³The settings for GS1 DataBar Truncated and GS1 DataBar must be the same.

1-4 Decode zone

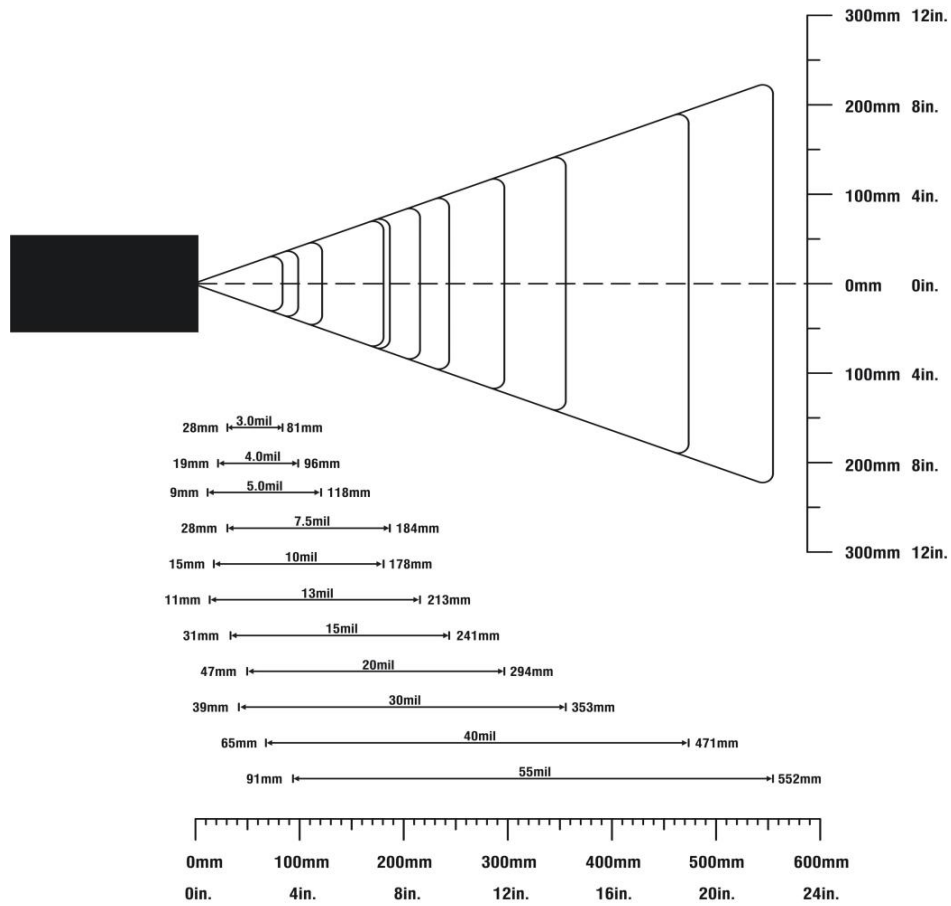

Figure 1-2 High-density series

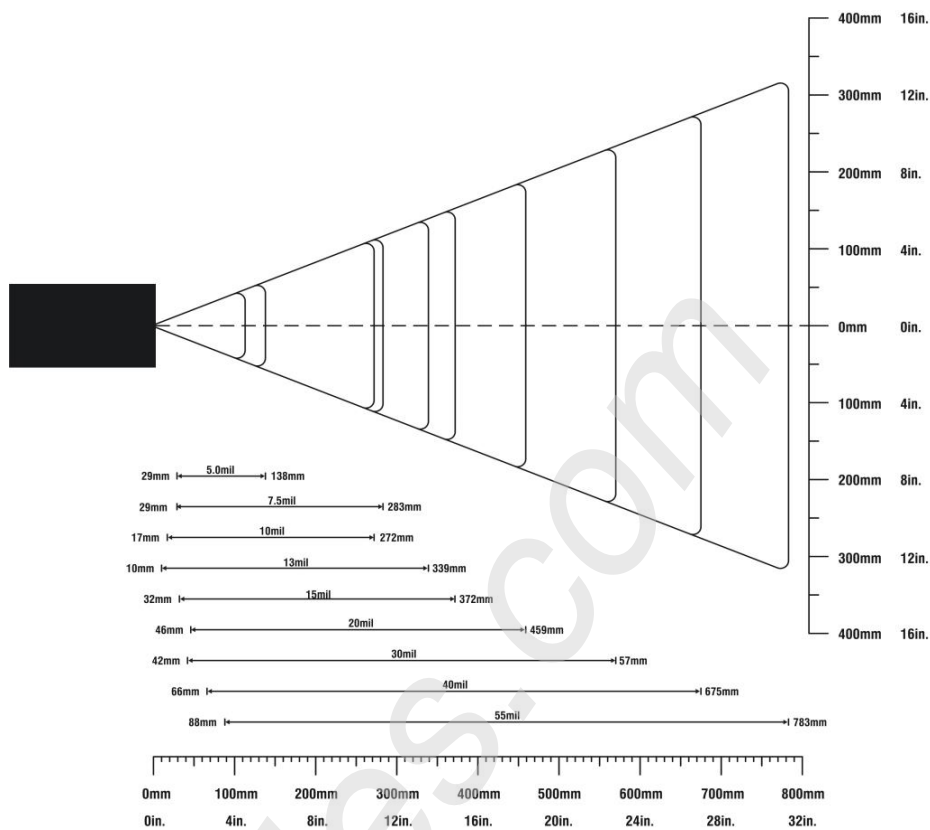

Figure 1-3 Long-range series

2 Installation guide

2-1 Important notes of installation

ESD

The scanner needs to be protected from ESD events that may occur in an ESD-controlled environment.

Magnetism

Mounting screws must be non-magnetic material. Do not place any magnetic material within 1 inch/ 2.54 cm of the chassis without testing.

2-2 Mounting

There are four mounting holes (M2) on the top of the chassis and it is shown in Figure 2-1.

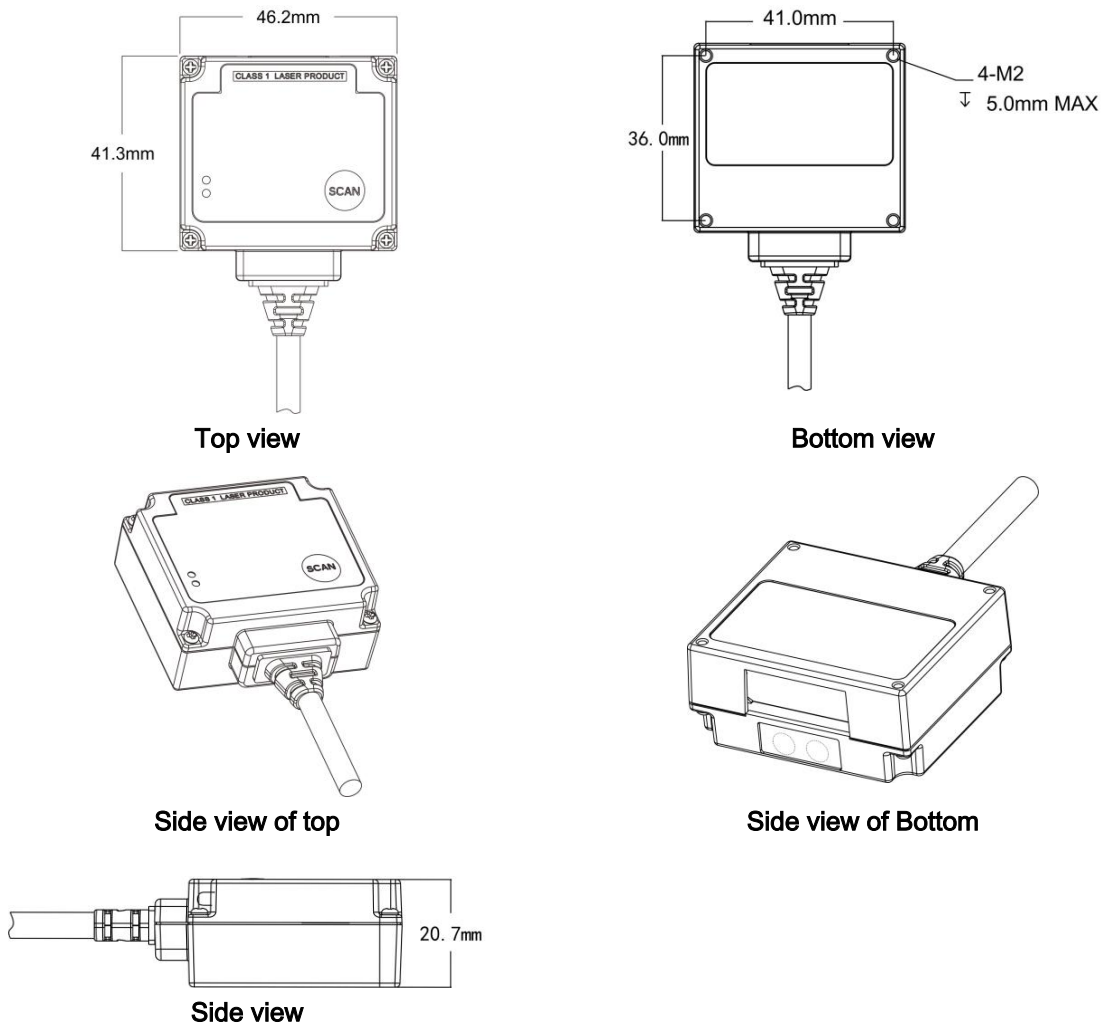

Figure 2-1 Mounting diagram

Notes: Mounting screws and locating pins must be non-magnetic material. Do not place any magnetic material within 1 inch of the chassis without testing.

2-3 Appearance of the scanner



Figure 2-2 Appearance of the scanner (with Zinc alloy case)



Figure 2-3 Appearance of the scanner (with ABS case)

2-4 Scan angle

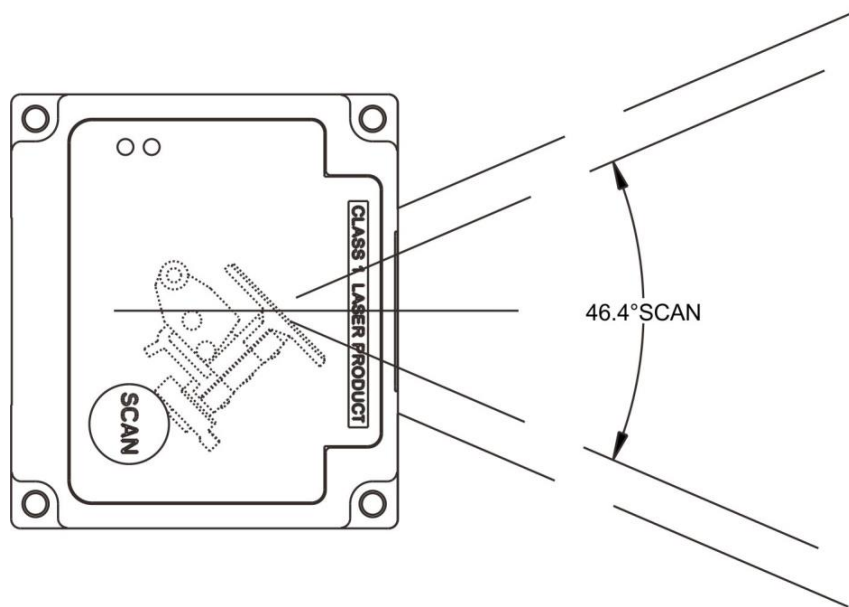

Figure 2-4 Scan angle

Note: The scanner's sealing condition can meet its own protection require. It's not necessary to add extra sealing protection.

3 Parameter menus

When the scanner is scanning, ensure the scan line crosses every bar and space of the symbol. See Figure 3-1.



Figure 3-1

3-1 Example: Configure scanner by scanning configuration barcodes

Throughout the programming barcode menus, the factory default settings are indicated with asterisks (*).

① Single-scan setting

Scan the appropriate Single-scan setting according to the user's demand.

Example: to set to be ACK/NAK.

Steps: Scan the following barcode.



② Multiple-scan setting

The steps of configuration are:

- 1) Scan the SETUP barcode on the parameter setting part.
- 2) Enter the option mode by scanning the Parameter name barcode.
- 3) To the right of the option barcode, the necessary alphanumeric inputs are listed. Scan these alphanumeric entries.
- 4) Scan the END barcode, listed on the bottom of each parameter setting part.
- 5) Notes that only one parameter can be setup at each time.

Example: to set to be none.

Steps: Scan the following barcodes in order.



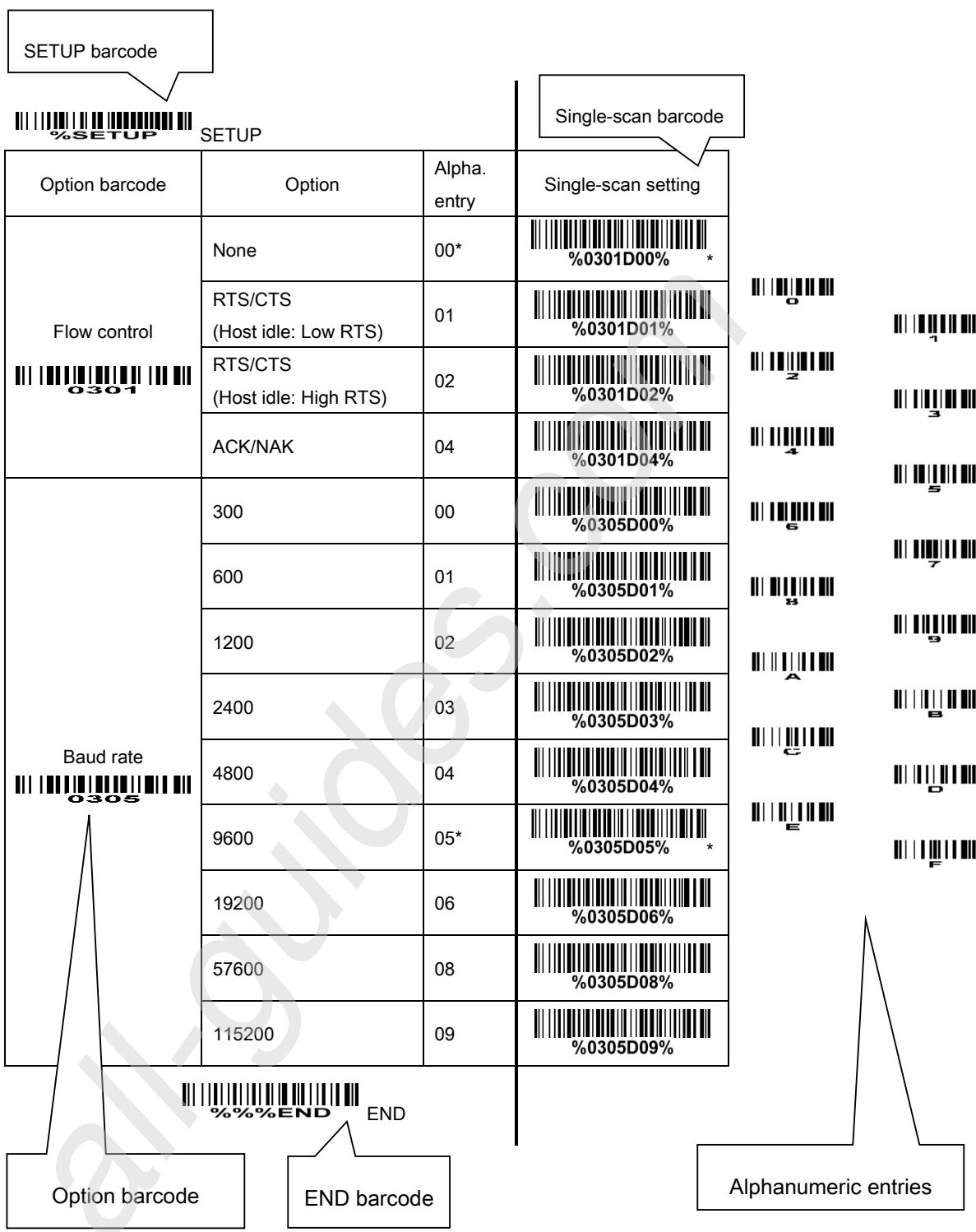

Figure 3-2 Set **Flow control** to be none

3-2 RS-232 interface

Flow control:

None-The communication only uses TXD and RXD signals without any hardware or software handshaking protocol.

RTS/CTS-If the scanner wants to send the barcode data to host computer, it will issue the RTS signal first, wait for the CTS signal from the host computer, and then perform the normal data communication. If there is no replied CTS signal from the host computer after the timeout duration, the scanner will issue an error indication. By setting (Host idle: Low RTS or Host idle: High RTS), the scanner can be set to match the Serial Host RTS line.

ACK/NAK-After data transmitted, the scanner expects either an ACK (acknowledge) or NAK (not acknowledge) response from the host. When a NAK is received, the scanner transmits the same data again and waits for either an ACK or NAK. After three unsuccessful attempts to send data when NAK are received, the scanner issues an error indication and discards the data.

Inter-character delay: This delay is inserted after each data character transmitted.

Response delay: This delay is used for serial communication of the scanner when it waits for a handshaking acknowledgment from the host.

Host-character delay: This delay is the time that the scanner waits for the host to send the next character in serial communication, it is based on 1ms increments.

Data package:

Disable: The scanner sends the decoded data directly.

Enable: The decoded data is sent in data package mode (see section "[4-4 DECODE_DATA](#)").



%SETUP

SETUP

Multiple-scan setting			Single-scan setting
Option barcode	Option	Alpha. entry	
Flow control 0301	None	00*	 %0301D00% *
	RTS/CTS (Host idle: Low RTS)	01	 %0301D01%
	RTS/CTS (Host idle: High RTS)	02	 %0301D02%
	ACK/NAK	04	 %0301D04%
Inter-character delay 0302	0 ms	00*	 %0302D00% *
	5 ms	01	 %0302D01%
	10 ms	02	 %0302D02%
	20 ms	03	 %0302D03%
	40 ms	04	 %0302D04%
	80 ms	05	 %0302D05%
Response delay 0304	00-99 (100 ms)	00-99	
		00*	 %0304D00% *
Baud rate 0305	300	00	 %0305D00%
	600	01	 %0305D01%
	1200	02	 %0305D02%
	2400	03	 %0305D03%
	4800	04	 %0305D04%
	9600	05*	 %0305D05% *



Multiple-scan setting			Single-scan setting
Option barcode	Option	Alpha. entry	
	19200	06	 %0305D06%
	38400	07	 %0305D07%
	57600	08	 %0305D08%
	115200	09	 %0305D09%
Parity 0306	None	00*	 %0306D00% *
	Odd	01	 %0306D01%
	Even	02	 %0306D02%
Data bit 0307	8 bits	00*	 %0307D00% *
	7 bits	01	 %0307D01%
Stop bit 0308	1 bits	00*	 %0308D00% *
	2 bits	01	 %0308D01%
Host-character delay 0309	00-99 (1ms)	00-99	
		00*	 %0309D00% *
Data package 0310	Disable	00*	 %0310D00% *
	Enable	01	 %0310D01%



3-3 USB interface

USB device type:

HID keyboard– By setting, the scanner is used as a USB HID keyboard emulation device.

USB virtual COM– By setting, the scanner emulate a regular RS232-based COM port. If a Microsoft Windows PC is connected to the scanner, a driver is required to install on the connected PC. The driver will use the next available COM Port number. The driver and the installation guide can be found in the associated CD and on the manufacturer's website. A Windows-based software COM_Text is recommended to display the barcode data in text format. COM_Text emulates some kind of serial-key typing.

The scanner will send the data in data package by the USB interface, if the data package is enabled (see section "[3-2 RS-232 Interface](#)"). while the USB works in USB virtual serial port operating mode, the USB virtual serial port will follow the ACK / NAK flow control, if the RS232 interface uses ACK / NAK flow control.

Simple COM Port Emulation- Please contact the manufacturer for the instruction.

Note: After changing USB Device Types, the scanner will automatically restart.

Keyboard layout: The scanner supports different national keyboard layouts.

Inter-character delay: This delay is inserted after each data character transmitted.



















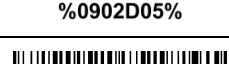

Numeric key:

Alphabetic key- the scanner will output code result as alphabetic key.

Numeric key- the scanner will output code result as pressing numeric keypad ('0', '1', '2', '3', '4', '5', '6', '7', '8', '9', '.', '+', '-', '/', '*' only).

Alt+ keypad- the scanner will output code result as pressing Alt+ numeric key (on keypad). Note that the Num Lock control key must be ON. This setting can be specially adapted for use with different national keyboard layout.



Multiple-scan setting			Single-scan setting
Option barcode	Option	Alpha. entry	
USB device type  0901	HID keyboard	00*	 %0901D00% *
	HID keyboard for Apple Mac	01	 %0901D01%
	USB virtual COM	02	 %0901D02%
	Simple COM Port Emulation	03	 %0901D03%
Keyboard layout  0902	USA	00*	 %0902D00% *
	Turkish F	01	 %0902D01%
	Turkish Q	02	 %0902D02%
	French	03	 %0902D03%
	Italian	04	 %0902D04%
	Spanish	05	 %0902D05%
	Slovak	06	 %0902D06%
	Denmark	07	 %0902D07%
	Japanese	08	 %0902D08%
	German	09	 %0902D09%
	Belgian	10	 %0902D10%
Russian	11	 %0902D11%	
Inter-character delay  0903	0 ms	00	 %0903D00%
	5 ms	01*	 %0903D01% *
	10 ms	02	 %0903D02%



%SETUP SETUP

Multiple-scan setting			Single-scan setting
Option barcode	Option	Alpha. entry	
	20 ms	03	 %0903D03%
	40 ms	04	 %0903D04%
	60 ms	05	 %0903D05%
Numeric key 0904	Alphabetic key	00*	 %0904D00% *
	Numeric keypad	01	 %0904D01%
	Alt+ keypad	02	 %0904D02%



%%END END

3-4 Scan mode & some global settings

Scan mode:

Good-read off-The trigger button must be pressed once to activate scanning. The light source of scanner stops scanning when there is a successful reading or no code is decoded after the **Stand-by duration** elapsed.

Momentary-The trigger button acts as a switch. Press button to activate scanning and release button to stop scanning. The light source of scanner stops scanning when there is a successful reading or no code is decoded after the **Stand-by duration** elapsed.

Alternate continue-The trigger button acts as a toggle switch. Press button to activate or stop scanning.

Continue-The scanner always keeps scanning, and it does not matter when the trigger button is pressed or duration is elapsed.

Timeout off-The trigger button must be pressed once to activate scanning. The light source of scanner stops scanning when no code is successful decoded after the **Stand-by duration** elapsed.

Auto-detection-The scanner will start scanning when an object closes to it. The light source of scanner stops scanning when there is a successful reading or no code is decoded after the **Stand-by duration** elapsed. The auto-detection function works again only after the object leaves the scanner. The trigger button is still valid when the auto-detection is enabled.

Good-read identification-The scanner will start to scan when it receives a GOOD_READ_START command (refer to "[4-14 GOOD_READ_START](#)"). The light source of scanner stops scanning when there is a successful reading or no code is decoded after the **Stand-by duration** elapsed. If it decodes successfully, the scanner will reply "<STX><]><CR><LF>". Otherwise, the scanner will reply "<STX><CAN><CR><LF>". When it receives a GOOD_READ_STOP command (refer to "[4-15 GOOD_READ_STOP](#)"), the scanner will stop scanning immediately. In this scan mode, the scanner still supports all the commands except START_DECODE and STOP_DECODE. Also, you can press trigger to scan the configuration-barcode to configure parameter or firmware version display barcode to get firmware version information. But if you scan the other barcodes, the scanner will not transmit the decoding result. In other scan modes, the GOOD_READ_START command and GOOD_READ_STOP command are invalid.

Note: Restoring the default settings by the host command or scanning the barcode has no affect on the scanning mode settings.

Same barcode delay time: If a barcode has been scanned and output once successfully, the laser beam must be off or moved away from the barcode beyond delay time to active scanning the same barcode. When this feature is set to be "0xFF", then the delay time is indefinite.

Double confirm: If it is enabled, the scanner will require a several times of same-decoded-data to confirm a valid reading.

Global Max./Min. code length: These two lengths are defined as the valid range of decoded barcode data length. Make sure that the minimum length setting is no greater than the maximum length setting, or

otherwise the labels of the symbol will not be readable. In particular, the same value can be set for both minimum and maximum reading length to force the fixed length barcode decoded.

Notes:

1. Please set the max./min. length for individual barcode in later sections, if special demand is requested.
2. The number of check digits is included in max./min. code length.
3. These two settings have no effect on the symbols with fixed-length, e.g. UPC-A, UPC-E, EAN-13, EAN-8 and China Post.

Global G1-G6 string selection: The scanner offer one or two string group for ALL symbols. By setting one or two digits to indicate which string group you want to apply. You may refer to the chapters of “[3-29 G1-G6 & FN1 substitution string setting](#)” and “[3-30 G1-G4 string position & Code ID position](#)”.

Example: Group 1 → set 01 or 10. Group 2 and 4 → set 24 or 42.

All valid settings include 00, 01, 02, 03, 04, 05, 06, 10, 11, 12, 13, 14, 15, 16, 20, 21, 22, 23, 24, 25, 26, 30, 31, 32, 33, 34, 35, 36, 40, 41, 42, 43, 44, 45, 46, 50, 51, 52, 53, 54, 55, 56, 60, 61, 62, 63, 64, 65 and 66.

Element amendment: If it is enabled, the scanner can read the barcode comprised with bars and spaces in different scale.

Printable character only: If this option is selected, the scanner will output the printable characters only, i.e. in ASCII from 20H to 7EH.

Decoder optimization: If it is enabled, the scanner will optimize the decoder with error correction. This function is not effective for all types of barcodes.

Data output delay in continue-scan mode: If it is enabled, in the continue-scan mode, the scanner can store the data while continue-scanning. The scanner will output the data after the predefined delay elapsed. The maximum storage of data is 1000 characters. If this parameter is set to be “00”, the scanner will not store data. And if the parameter is set to be “FF”, the scanner will output data after stopping scanning.

Enter sleeping-mode delay: The scanner will enter sleeping mode if the scanner’s idle state time surpasses the predefined delay time. When the scanner’s scanning mode is Auto-detection, it can be awaked by sensor, scan button or command. And when the scanner is set in other scanning mode, it can be awaked by scan button or command.



%SETUP SETUP

Multiple-scan setting			Single-scan setting
Option barcode	Option	Alpha. entry	
Scanning mode 0401	Good-read off	00	 %0401D00%
	Momentary	01	 %0401D01%
	Alternate continue	02	 %0401D02%
	Continue	03	 %0401D03%
	Timeout off	04	 %0401D04%
	Auto-detection	05	 %0401D05%
	Good-read identification	06	 %0401D06%
Standby duration 0402	01-99 (second)	01-99	
		04*	 %0402D04% *
Same barcode delay time 0403	00-FF ₁₆ (50 second)	00-FF ₁₆	
		00	 %0403H00%
		0A*	 %0403H0A% *
Double confirm 0404	00-09 (00:no)	00-09	
		00*	 %0404D00% *
Global max. code length 0405	04-99	04-99	
		99*	 %0405D99% *
Global min. code length 0406	01-99	01-99	
		04*	 %0406D04% *
Global G1-G6 string selection	00-66	00-66	



%SETUP SETUP

Multiple-scan setting			Single-scan setting
Option barcode	Option	Alpha. entry	
 0407		00*	 %0407D00% *
Element amendment 0408	Disable	00	 %0408D00%
	Enable	01*	 %0408D01% *
Character output restraint 0409	None	00*	 %0409D00% *
	Printable character only	01	 %0409D01%
	Alphanumeric character only	02	 %0409D02%
Decoder optimization 0410	Disable	00	 %0410D00%
	Enable	01*	 %0410D01% *
Data output delay in continue-scan mode 0411	00-FF ₁₆ (100 ms)	00-FF ₁₆	
	FF ₁₆ (Never)	00*	 %0411H00% *
Enter sleeping-mode delay 0412	10 second	00	 %0412D00%
	3 min	01	 %0412D01%
	15 min	02	 %0412D02%
	30 min	03*	 %0412D03% *
	60 min	04	 %0412D04%
	6 hour	05	 %0412D05%
	Never	06	 %0412D06%



%%END END













3-5 Indication

Power on alert: After power-on the scanner will generate an alert signal to indicate a successful self-test.

Beeper indication: After each successful reading, the scanner will beep to indicate a good barcode reading, and its beep tone duration is adjustable.

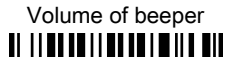
Beep tone duration: This parameter can be adjusted for a good reading upon favorite usage.

Volume of beeper: This parameter can be adjusted for different level of the volume of the beeper.

Multiple-scan setting			Single-scan setting
Option barcode	Option	Alpha. entry	
Power on alert  0501	Disable	00	 %0501D00%
	Enable	01*	 %0501D01% *
Reserved  0502			
Beeper indication  0503	Disable	00	 %0503D00%
	Enable	01*	 %0503D01% *
Beep tone duration  0504	01-09 (10 ms)	01-09	
		05*	 %0504D05% *
Volume of beeper  0505	Low	00	 %0505D00%
	Middle	01	 %0505D01%
	High	02*	 %0505D02% *

 %%%END END

3-6 UPC-A

Read: Format

System character	Data digits (10 digits)	Check digit
------------------	-------------------------	-------------

Check digit verification: The check digit verification is optional.

Check digit trans.: By setting Enable, check digit will be transmitted.

Code ID setting: Code ID is a one-or-two-character string used to represent the symbol upon a succeeding reading. If you want application to transmit Code ID, you must set **Code ID transmission** to be enabled. Refer to the chapter of “[3-31 String transmission](#)”.

Insertion group selection: Refer to **Global insertion group selection** of the chapter of “[3-4 Scan mode & some global settings](#)” .

Supplement digits: The Supplement digits barcode is the supplemental 2 or 5 characters.

Format

System character	Data digits (10 digits)	Check digit	Supplement digits 2 or 5
------------------	-------------------------	-------------	--------------------------

Truncation/Expansion:

Truncate leading zeros - The leading “0” digits of UPC-A data characters can be truncated when the feature is enabled.

Example: Barcode “001234567895”,

Output: “1234567895”.

Expand to EAN-13 - It extends to 13-digits with a “0” leading digit when the feature is enabled.

Example: Barcode “001234567895”,

Output: “0001234567895”.

Truncate system character - The system character of UPC-A data can be truncated when the feature is enabled.

Example: Barcode “001234567895”,

Output: “01234567895”.

Add country code - The country code (“0” for USA) can be added when the feature is enabled.

Example: Barcode “001234567895”,

Output: “0001234567895”.



Multiple-scan setting			Single-scan setting
Option barcode	Option	Alpha. entry	
Read 1101	Disable	00	 %1101D00%
	Enable	01*	 %1101D01% *
Check digit verification 1102	Disable	00	 %1102D00%
	Enable	01*	 %1102D01% *
Check digit trans. 1103	Disable	00	 %1103D00%
	Enable	01*	 %1103D01% *
Code ID setting 1104	00-FF ₁₆ (ASCII)	00-FF ₁₆	
		<A>*	 %1104H41% *
Insert group selection 1105	00-66	00-66	
		00*	 %1105D00%
Supplement digits 1106	None	00*	 %1106D00% *
	2 digits	01	 %1106D01%
	5 digits	02	 %1106D02%
	2 or 5 digits	03	 %1106D03%
Truncation/Expansion 1107	None	00*	 %1107D00% *
	Truncate leading zeros	01	 %1107D01%
	Expand to EAN-13	02	 %1107D02%
	Add country code	04	 %1107D04%
	Add country code	04	 %1107D04%



3-7 UPC-E

Read: Format

System character "0"	Data digits (6 digits)	Check digits
----------------------	------------------------	--------------

Check digit verification: The check digit verification is optional.

Check digit trans.: By setting Enable, check digit will be transmitted.

Code ID setting: Refer to Code ID setting of "*3-6 UPC-A*".

Insertion group selection: Refer to Insertion group selection of "*3-6 UPC-A*".

Supplement digits:

Format

System character "0"	Data digits (6 digits)	Check digit	Supplement digits 2 or 5
----------------------	------------------------	-------------	--------------------------

Truncation/Expansion:

Truncate leading zeros - The leading "0" digits of UPC-E data characters can be truncated when the feature is enabled.

Example: Barcode "00123457",

Output: "123457".

Expand to EAN-13 - It extends to 13-digits with a "0" leading digit when the feature is enabled.

Example: Barcode "00123457",

Output: "0001234000057".

Expand to UPC-A - It extends to 12-digits when the feature is set to be enabled.

Example: Barcode "00123457",

Output: "001234000057".

Truncate system character - The system character "0" of UPC-E data can be truncated when the feature is enabled.

Example: Barcode "00123457",

Output: "0123457".

Add country code - The country code ("0" for USA) can be added when the feature is enabled.

Example: Barcode "00123457",

Output: "000123457".



Multiple-scan setting			Single-scan setting
Option barcode	Option	Alpha. entry	
Read 1201	Disable	00	
	Enable	01*	*
Check digit verification 1202	Disable	00	
	Enable	01*	*
Check digit trans. 1203	Disable	00	
	Enable	01*	*
Code ID setting 1204	00-FF ₁₆ (ASCII)	00-FF ₁₆	
		<D>*	*
Insert group selection 1205	00-66	00-66	
		00*	*
Supplement digits 1206	None	00*	*
	2 digits	01	
	5 digits	02	
	2 or 5 digits	03	
Truncation/Expansion 1207	None	00*	*
	Truncate leading zeros	01	
	Expand to EAN-13	02	
	Expand to UPC-A	03	
	Truncate system character	04	
	Add country code	05	



3-8 UPC-E1

Read: Format

System character "1"	Data digits (6 digits)	Check digits
----------------------	------------------------	--------------

Check digit verification: The check digit verification is optional.

Check digit trans.: By setting Enable, check digit will be transmitted.

Code ID setting: Refer to Code ID setting of "*3-6 UPC-A*".

Insertion group selection: Refer to Insertion group selection of "*3-6 UPC-A*".

Supplement digits:

Format

System character "1"	Data digits (6 digits)	Check digit	Supplement digits 2 or 5
----------------------	------------------------	-------------	--------------------------

Truncation/Expansion:

Expand to EAN -13 - It extends to 13-digits with "0" digits when the feature is enabled.

Example: Barcode "10012341",

Output: "0100120000031".

Expand to UPC-A - It extends to 12-digits when the feature is set to be enabled.

Example: Barcode "10012341",

Output: "100120000031".

Truncate system character - The system character "1" of UPC-E1 data can be truncated when the feature is enabled.

Example: Barcode "10012341",

Output: "0012341".

Add country code - The country code ("0" for USA) can be added when the feature is enabled.

Example: Barcode "10012341",

Output: "010012341".



Multiple-scan setting			Single-scan setting
Option barcode	Option	Alpha. entry	
Read 3401	Disable	00	 %3401D00%
	Enable	01*	 %3401D01% *
Check digit verification 3402	Disable	00	 %3402D00%
	Enable	01*	 %3402D01% *
Check digit trans. 3403	Disable	00	 %3403D00%
	Enable	01*	 %3403D01% *
Code ID setting 3404	00-FF ₁₆ (ASCII)	00-FF ₁₆	
		<D>*	 %3404H20% *
Insert group selection 3405	00-66	00-66	
		00*	 %3405D00% *
Supplement digits 3406	None	00*	 %3406D00% *
	2 digits	01	 %3406D01%
	5 digits	02	 %3406D02%
	2 or 5 digits	03	 %3406D03%
Truncation/Expansion 3407	None	00*	 %3407D00% *
	Expand to EAN-13	02	 %3407D02%
	Expand to UPC-A	03	 %3407D03%
	Truncate system character	04	 %3407D04%
	Add country code	05	 %3407D05%



3-9 EAN-13 (ISBN/ISSN)

Read:

Format

Data digits (12 digits)	Check digit
-------------------------	-------------

Check digit verification: The check digit verification is optional .

Check digit transmission: By setting Enable, check digit will be transmitted.

EAN-13 code ID setting: Refer to Code ID setting of “3-6 UPC-A”.

Insertion group selection: Refer to Insertion group selection of “3-6 UPC-A”.

Supplement digits:

Format

Data digits (12 digits)	Check digit	Supplement digits 2 or 5
-------------------------	-------------	--------------------------

ISBN/ISSN conversion: The ISBN (International Standard Book Number) and ISSN (International Standard Serial Number) are two kinds of barcode for books and magazines. The ISBN is 10 digits with leading “978” and the ISSN is 8 digits with leading “977” of the EAN-13 symbol.

Example:

Barcode “9780194315104”, Output: “019431510X”.

Barcode “9771005180004”, Output: “10051805”.

ISBN/ISSN code ID setting: Refer to Code ID setting of “3-6 UPC-A”.

Multiple-scan setting			Single-scan setting
Option barcode	Option	Alpha. entry	
Read  1301	Disable	00	 %1301D00%
	Enable	01*	 %1301D01% *
Check digit verification  1302	Disable	00	 %1302D00%
	Enable	01*	 %1302D01% *
Check digit transmission  1303	Disable	00	 %1303D00%
	Enable	01*	 %1303D01% *
EAN-13 code ID setting  1304	00-FF ₁₆ (ASCII)	00-FF ₁₆	
		<A>*	 %1304H41% *



%SETUP SETUP

Multiple-scan setting			Single-scan setting
Option barcode	Option	Alpha. entry	
Insert group selection  1305	00-66	00-66	
		00*	 %1305D00% *
Supplement digits  1306	None	00*	 %1306D00% *
	2 digits	01	 %1306D01%
	5 digits	02	 %1306D02%
	2 or 5 digits	03	 %1306D03%
ISBN/ISSN conversion  1307	Disable	00*	 %1307D00% *
	Enable	01	 %1307D01%
ISBN/ISSN code ID setting  1309	00-FF ₁₆ (ASCII)	00-FF ₁₆	
		*	 %1309H42% *



%%END END

3-10 EAN-8**Read:**

Format

Data digits (7 digits)	Check digit
------------------------	-------------

Check digit verification: The check digit verification is optional.

Check digit trans.: By setting Enable, check digit will be transmitted.

Code ID setting: Refer to Code ID setting of "3-6 UPC-A".

Insertion group selection: Refer to Insertion group selection of "3-6 UPC-A".

Supplement digits:

Format

Data digits (7 digits)	Check digit	Supplement Digits 2 or 5
------------------------	-------------	--------------------------

Truncation/Expansion: Refer to Truncation/Expansion of "3-6 UPC-A".



%SETUP SETUP

Multiple-scan setting			Single-scan setting
Option barcode	Option	Alpha. entry	
Read 1401	Disable	00	%1401D00%
	Enable	01*	%1401D01% *
Check digit verification 1402	Disable	00	%1402D00%
	Enable	01*	%1402D01% *
Check digit trans. 1403	Disable	00	%1403D00%
	Enable	01*	%1403D01% *
Code ID setting 1404	00-FF ₁₆ (ASCII)	00-FF ₁₆	
		<C>*	%1404H42% *
Insert group selection 1405	00-66	00-66	
		00*	%1405D00% *
Supplement digits 1406	None	00*	%1406D00% *
	2 digits	01	%1406D01%
	5 digits	02	%1406D02%
	2 or 5 digits	03	%1406D03%
Truncation/Expansion 1407	None	00*	%1407D00% *
	Truncate leading zero	01	%1407D01%
	Expand to EAN-13	02	%1407D02%



%%END END

3-11 Code 39 (Code 32, Trioptic Code 39)

Read:

Format

Start character(*)	Data digits (variable)	Check digit (optional)	End character (*)
--------------------	------------------------	------------------------	-------------------

Check digit verification: The check digit verification is optional.

Check digit transmission: By setting Enable, check digit will be transmitted.

Max./Min. code length: Each symbol has own max./min. code length. If both setting of max./min. code length are "00"s, the setting of global max./min. code length is effective. The length is defined as to the actual barcode data length to be sent. Label with length exceeds these limits will be rejected. Make sure that the minimum length setting is no greater than the maximum length setting, or otherwise all the labels of the symbol will not be readable. In particular, you can see the same value for both minimum and maximum reading length to force the fixed length barcode decoded.

Code ID setting: Refer to

Code ID setting

 of "*3-6 UPC-A*".

Insertion group selection: Refer to

Insertion group selection

 of "*3-6 UPC-A*".

Start/End transmission: The start and end characters of Code 39 are "*"s. You can transmit all data digits including two "*"s.

**** as data character:** By setting Enable, "*" can be recognized as data character.

Convert Code 39 to Code 32: Code 32 is a variant of Code 39 used by the Italian pharmaceutical industry. Note that Code 39 must be enabled in order for this parameter to function.

Format of Code 32

"A" (optional)	Data digits (8 digits)	Check digit
----------------	------------------------	-------------

Code 32 Prefix "A" transmission: By setting Enable, the prefix character "A" can be added to all Code 32 barcodes.

Trioptic Code 39 read: Trioptic Code 39 is a variant of Code 39 used in the marking of magnetic tapes and computer cartridges. Trioptic Code 39 symbols always contain six characters.

Format

Start character (\$)	Data digits (6 digits)	End character (\$)
----------------------	------------------------	--------------------

Trioptic Code 39 Start/End transmission: The start and end characters of Trioptic Code 39 are "\$"s. You can transmit all data digits including two "\$"s.



Multiple-scan setting			Single-scan setting
Option barcode	Option	Alpha. entry	
Read 1501	Disable	00	%1501D00%
	Enable	01*	%1501D01% *
Check digit verification 1502	Disable	00*	%1502D00% *
	Enable	01	%1502D01%
Check digit transmission 1503	Disable	00*	%1503D00% *
	Enable	01	%1503D01%
Max. code length 1504	00-99	00-99	
		00*	%1504D00% *
Min. code length 1505	00-99	00-99	
		01*	%1505D01% *
Code ID setting 1506	00-FF ₁₆ (ASCII)	00-FF ₁₆	
		<M>*	%1506H4D% *
Insert group selection 1507	00-66	00-66	
		00*	%1507D00% *
Format 1508	Standard	00*	%1508D00% *
	Full ASCII	01	%1508D01%
Start/End transmission 1509	Disable	00*	%1509D00% *
	Enable	01	%1509D01%
"*" as data character 1510	Disable	00*	%1510D00% *
	Enable	01	%1510D01%



Multiple-scan setting			Single-scan setting
Option barcode	Option	Alpha. entry	
Convert Code 39 to Code 32  1511	Disable	00*	 %1511D00% *
	Enable	01	 %1511D01%
Code 32 Prefix "A" transmission  1512	Disable	00*	 %1512D00% *
	Enable	01	 %1512D01%
Trioptic Code 39 read  1513	Disable	00*	 %1513D00% *
	Enable	01	 %1513D01%
Trioptic Code 39 Start/End transmission  1514	Disable	00*	 %1514D00% *
	Enable	01	 %1514D01%



Note 1: If Trioptic Code 39 is set Enable, Code 39 is forced Enable.

Note 2: If Code 39 is set Disable, Trioptic Code 39 is forced Disable.

3-12 Interleaved 2 of 5

Read:

Format

Data digits (Variable)	Check digit (optional)
------------------------	------------------------

Check digit verification: The check digit verification is optional.

Check digit transmission: By setting Enable, check digit will be transmitted.

Max./Min. code length: Refer to Max./Min. code length of “*3-11 Code 39 (Code 32, Trioptic Code 39)*”.

Code ID setting: Refer to Code ID setting of “*3-6 UPC-A*”.

Insertion group selection: Refer to Insertion group selection of “*3-6 UPC-A*”.

all-guides.com



%SETUP SETUP

Multiple-scan setting			Single-scan setting
Option barcode	Option	Alpha. entry	
Read 1601	Disable	00	 %1601D00%
	Enable	01*	 %1601D01% *
Check digit verification 1602	Disable	00*	 %1602D00% *
	USS	01	 %1602D01%
	OPCC	02	 %1602D02%
Check digit transmission 1603	Disable	00*	 %1603D00% *
	Enable	01	 %1603D01%
Max. code length 1604	00-99	00-99	
		00*	 %1604D00% *
Min. code length 1605	00-99	00-99	
		06*	 %1605D06% *
Code ID setting 1606	00-FF ₁₆ (ASCII)	00-FF ₁₆	
		< >*	 %1606H49% *
Insert group selection 1607	00-66	00-66	
		00*	 %1607D00% *



%%%END END

3-13 Industrial 2 of 5

Read:

Format

Data digits (variable)

Check digit transmission: By setting Enable, check digit will be transmitted.

Max./Min. code length: Refer to Max./Min. code length of "3-11 Code 39 (Code 32, Trioptic Code 39)".

Code ID setting: Refer to Code ID setting of "3-6 UPC-A".

Insertion group selection: Refer to Insertion group selection of "3-6 UPC-A".

Multiple-scan setting			Single-scan setting
Option barcode	Option	Alpha. entry	
Read  1701	Disable	00*	 %1701D00% *
	Enable	01	 %1701D01%
Max. code length  1702	00-99	00-99	
		00*	 %1702D00% *
Min. code length  1703	00-99	00-99	
		00*	 %1703D00% *
Code ID setting  1704	00-FF ₁₆ (ASCII)	00-FF ₁₆	
		<H>*	 %1704H48% *
Insert group selection  1705	00-66	00-66	
		00*	 %1705D00% *

 %%%END END

3-14 Matrix 2 of 5

Read:

Format

Data digits (variable)	Check digit (optional)
------------------------	------------------------

Check digit verification: The check digit verification is optional.

Check digit transmission: By setting Enable, check digit will be transmitted.

Max./Min. code length: Refer to

Max./Min. code length

 of "*3-11 Code 39 (Code 32, Trioptic Code 39)*".

Code ID setting: Refer to

Code ID setting

 of "*3-6 UPC-A*".

Insertion group selection: Refer to

Insertion group selection

 of "*3-6 UPC-A*".



%SETUP SETUP

Multiple-scan setting			Single-scan setting
Option barcode	Option	Alpha. entry	
Read 1801	Disable	00	%1801D00%
	Enable	01*	%1801D01% *
Check digit verification 1802	Disable	00*	%1802D00% *
	Enable	01	%1802D01%
Check digit transmission 1803	Disable	00*	%1803D00% *
	Enable	01	%1803D01%
Max. code length 1804	00-99	00-99	
		00*	%1804D00% *
Min. code length 1805	00-99	00-99	
		06*	%1805D06% *
Code ID setting 1806	00-FF ₁₆ (ASCII)	00-FF ₁₆	
		<X>*	%1806H58% *
Insert group selection 1807	00-44	00-44	
		00*	%1807D00% *



%%END END

3-15 Codabar

Read:

Format

Start character	Data digits (variable)	Check digit (optional)	End character
-----------------	------------------------	------------------------	---------------

Check digit verification: The check digit verification is optional.

Check digit transmission: By setting Enable, check digit will be transmitted.

Max./Min. code length: Refer to **Max./Min. code length** of “[3-11 Code 39 \(Code 32, Trioptic Code 39\)](#)”.

Code ID setting: Refer to **Code ID setting** of “[3-6 UPC-A](#)”.

Insertion group selection: Refer to **Insertion group selection** of “[3-6 UPC-A](#)”.















Start/End type: Codabar has four pairs of Start/End pattern; you may select one pair to match your application.

Start/End transmission: Refer to **Start/End transmission** of “[3-11 Code 39 \(Code 32, Trioptic Code 39\)](#)”.

Start/End character equality: By setting Enable, the start and end character of a Codabar barcode must be the same.

Multiple-scan setting			Single-scan setting
Option barcode	Option	Alpha. entry	
Read  1901	Disable	00	 %1901D00%
	Enable	01*	 %1901D01% *
Check digit verification  1902	Disable	00*	 %1902D00% *
	Enable	01	 %1902D01%
Check digit transmission  1903	Disable	00*	 %1903D00% *
	Enable	01	 %1903D01%
Max. code length  1904	00-99	00-99	
		00*	 %1904D00% *
Min. code length  1905	00-99	00-99	
		00*	 %1905D00% *

 **%SETUP** SETUP

Multiple-scan setting			Single-scan setting
Option barcode	Option	Alpha. entry	
Code ID setting  1906	00-FF ₁₆ (ASCII)	00-FF ₁₆	
		<N>*	 %1906H4E% *
Insert group selection  1907	00-66	00-66	
		00*	 %1907D00% *
Start/End type  1908	ABCD/ABCD	00*	 %1908D00% *
	abcd/abcd	01	 %1908D01%
	ABCD/TN*E	02	 %1908D02%
	abcd/tn*e	03	 %1908D03%
Start/End transmission  1909	Disable	00*	 %1909D00% *
	Enable	01	 %1909D01%
Start/End character equality  1910	Disable	00*	 %1910D00% *
	Enable	01	 %1910D01%

 **%%END** END

3-16 Code 128

Read:

Format

Data digits (variable)	Check digit (optional)
------------------------	------------------------

Check digit verification: The check digit verification is optional.

Check digit transmission: By setting Enable, check digit will be transmitted.

Max./Min. code length: Refer to

Max./Min. code length

 of "[3-11 Code 39 \(Code 32, Trioptic Code 39\)](#)".

Code ID setting: Refer to

Code ID setting

 of "[3-6 UPC-A](#)".

Insertion group selection: Refer to

Insertion group selection

 of "[3-6 UPC-A](#)".

Truncate leading zeros: The leading "0" digits or all "0" digits of Code 128 barcode characters can be truncated when the feature is enabled.



%SETUP SETUP

Multiple-scan setting			Single-scan setting
Option barcode	Option	Alpha. entry	
Read 2001	Disable	00	%2001D00%
	Enable	01*	%2001D01% *
Check digit verification 2002	Disable	00	%2002D00%
	Enable	01*	%2002D01% *
Check digit transmission 2003	Disable	00*	%2003D00% *
	Reserved	01	%2003D01%
Max. code length 2004	00-99	00-99	
		00*	%2004D00% *
Min. code length 2005	00-99	00-99	
		01*	%2005D01% *
Code ID setting 2006	00-FF ₁₆ (ASCII)	00-FF ₁₆	
		<K>*	%2006H4B% *
Insert group selection 2007	00-66	00-66	
		00*	%2007D00% *
Truncate leading zeros 2008	Disable	00*	%2008D00% *
	All leading "0"s	01	%2008D01%
	Only the first "0"	02	%2008D02%



%%%END END

3-17 UCC/EAN 128

Read:

Format

Data digits (variable)	Check digit (optional)
------------------------	------------------------

Check digit verification: The check digit verification is optional.

Check digit transmission: By setting Enable, check digit will be transmitted.

Max. /Min. code length: Refer to

Max./Min. code length

 of "[3-11 Code 39 \(Code 32, Trioptic Code 39\)](#)".

Code ID setting: Refer to

Code ID setting

 of "[3-6 UPC-A](#)".

Insertion group selection: Refer to

Insertion group selection

 of "[3-6 UPC-A](#)".

Truncate leading zeros: Refer to

Truncate leading zeros

 of "[3-16 Code 128](#)".



%SETUP SETUP

Multiple-scan setting			Single-scan setting
Option barcode	Option	Alpha. entry	
Read 2501	Disable	00	 %2501D00%
	Enable	01*	 %2501D01% *
Check digit verification 2502	Disable	00	 %2502D00%
	Enable	01*	 %2502D01% *
Check digit transmission 2503	Disable	00*	 %2503D00% *
	Reserved	01	 %2503D01%
Max. code length 2504	00-99	00-99	
		00*	 %2504D00% *
Min. code length 2505	00-99	00-99	
		01*	 %2505D01% *
Code ID setting 2506	00-FF ₁₆ (ASCII)	00-FF ₁₆	
		<K>*	 %2506H4B% *
Insert group selection 2507	00-66	00-66	
		00*	 %2507D00% *
Truncate leading zeros 2508	Disable	00*	 %2508D00% *
	All leading "0"s	01	 %2508D01%
	Only the first "0"	02	 %2508D02%



%%END END

3-18 ISBT 128

Read:

Format

"=" or "&"	Data digits (variable)	Check digit (optional)
------------	------------------------	------------------------

Check digit verification: The check digit verification is optional.

Check digit transmission: By setting Enable, check digit will be transmitted.

Max./Min. code length: Refer to

Max./Min. code length

 of "[3-11 Code 39 \(Code 32, Trioptic Code 39\)](#)".

Code ID setting: Refer to





Code ID setting

 of "[3-6 UPC-A](#)".

Insertion group selection: Refer to

Insertion group selection

 of "[3-6 UPC-A](#)".

Multiple-scan setting			Single-scan setting
Option barcode	Option	Alpha. entry	
Read  3301	Disable	00	 %3301D00%
	Enable	01*	 %3301D01% *
Check digit verification  3302	Disable	00	 %3302D00%
	Enable	01*	 %3302D01% *
Check digit transmission  3303	Disable	00*	 %3303D00% *
	Reserved	01	 %3303D01%
Max. code length  3304	00-99	00-99	
		00*	 %3304D00% *
Min. code length  3305	00-99	00-99	
		01*	 %3305D01% *
Code ID setting  3306	00- FF ₁₆ (ASCII)	00-FF ₁₆	
		<K>*	 %3306H4B% *
Insert group selection  3307	00-66	00-66	
		00*	 %3307D00% *

 %%%END END

3-19 Code 93

Read:

Format

Data digits (variable)	2 check digits (optional)
------------------------	---------------------------

Check digit verification: The check digit verification is optional.

Check digit transmission: By setting Enable, check digit will be transmitted.

Max./Min. code length: Refer to

Max./Min. code length

 of "[3-11 Code 39 \(Code 32, Trioptic Code 39\)](#)".

Code ID setting: Refer to

Code ID setting

 of "[3-6 UPC-A](#)".

Insertion group selection: Refer to

Insertion group selection

 of "[3-6 UPC-A](#)".



%SETUP SETUP

Multiple-scan setting			Single-scan setting
Option barcode	Option	Alpha. entry	
Read 2101	Disable	00	 %2101D00%
	Enable	01*	 %2101D01% *
Check digit verification 2102	Disable	00	 %2102D00%
	Enable	01*	 %2102D01% *
Check digit transmission 2103	Disable	00*	 %2103D00% *
	Enable	01	 %2103D01%
Max. code length 2104	00-99	00-99	
		00*	 %2104D00% *
Min. code length 2105	00-99	00-99	
		01*	 %2105D01% *
Code ID setting 2106	00-FF ₁₆ (ASCII)	00-FF ₁₆	
		<L>*	 %2106H4C% *
Insert group selection 2107	00-66	00-66	
		00*	 %2107D00% *



%%%END END

3-20 Code 11

Read:

Format

Data digits (variable)	Check digit 1 (optional)	Check digit 2 (optional)
------------------------	---------------------------	--------------------------

Check digit verification: The check digit verification is optional.

Check digit transmission: By setting Enable, check digit 1 and check digit 2 will be transmitted upon the selected check digit verification method.

Max./Min. code length: Refer to

Max./Min. code length

 of "[3-11 Code 39 \(Code 32, Trioptic Code 39\)](#)".

Code ID setting: Refer to

Code ID setting

 of "[3-6 UPC-A](#)".

Insertion group selection: Refer to

Insertion group selection

 of "[3-6 UPC-A](#)".



%SETUP SETUP

Multiple-scan setting			Single-scan setting
Option barcode	Option	Alpha. entry	
Read 2201	Disable	00*	 %2201D00% *
	Enable	01	 %2201D01%
Check digit verification 2202	Disable	00	 %2202D00%
	1 digit	01*	 %2202D01% *
	Reserved	02	 %2202D02%
	Reserved	03	 %2202D03%
Check digit transmission 2203	Disable	00*	 %2203D00% *
	Enable	01	 %2203D01%
Max. code length 2204	00-99	00-99	
		00*	 %2204D00% *
Min. code length 2205	00-99	00-99	
		00*	 %2205D00% *
Code ID setting 2206	00-FF ₁₆ (ASCII)	00-FF ₁₆	
		<V>*	 %2206H56% *
Insert group selection 2207	00-66	00-66	
		00*	 %2207D00% *



%%END END

3-21 MSI/Plessey

Read:

Format

Data digits (variable)	Check digit 1 (optional)	Check digit 2 (optional)
------------------------	--------------------------	--------------------------

Check digit verification: The MSI/Plessey has one or two optional check digits. There are three methods to verify check digits, i.e. Mod10, Mod10/10 and Mod 11/10. The check digit 1 and check digit 2 will be calculated as the sum module 10 or 11 of the data digits.

Check digit transmission: By setting Enable, check digit 1 and check digit 2 will be transmitted upon the selected check digit verification method.

Max./Min. code length: Refer to

Max./Min. code length

 of "[3-11 Code 39 \(Code 32, Trioptic Code 39\)](#)".

Code ID setting: Refer to

Code ID setting

 of "[3-6 UPC-A](#)".

Insertion group selection: Refer to

Insertion group selection

 of "[3-6 UPC-A](#)".



%SETUP SETUP

Multiple-scan setting			Single-scan setting
Option barcode	Option	Alpha. entry	
Read 2301	Disable	00*	 %2301D00% *
	Enable	01	 %2301D01%
Check digit verification 2302	Disable	00*	 %2302D00% *
	1 digit (mod 10)	01	 %2302D01%
	Reserved	02	 %2302D02%
	Reserved	03	 %2302D03%
Check digit transmission 2303	Disable	00*	 %2303D00% *
	Enable	01	 %2303D01%
Max. code length 2304	00-99	00-99	
		00*	 %2304D00% *
Min. code length 2305	00-99	00-99	
		00*	 %2305D00% *
Code ID setting 2306	00-FF ₁₆ (ASCII)	00-FF ₁₆	
		<O>*	 %2306H4F% *
Insert group selection 2307	00-66	00-66	
		00*	 %2307D00% *



%%%END END

3-22 UK/Plessey

Read:

Format

Data digits (variable)	2 check digits (optional)
------------------------	---------------------------

Check digit verification: The UK/Plessey has one or two optional check digits. The check digit 1 and check digit 2 will be calculated as the sum module 10 or 11 of the data digits.

Check digit transmission: By setting Enable, check digit will be transmitted.

Max./Min. code length: Refer to

Max./Min. code length

 of "[3-11 Code 39 \(Code 32, Trioptic Code 39\)](#)".

Code ID setting: Refer to

Code ID setting

 of "[3-6 UPC-A](#)".

Insertion group selection: Refer to

Insertion group selection

 of "[3-6 UPC-A](#)".



%SETUP SETUP

Multiple-scan setting			Single-scan setting
Option barcode	Option	Alpha. entry	
Read 2401	Disable	00*	 %2401D00% *
	Enable	01	 %2401D01%
Check digit verification 2402	Disable	00	 %2402D00%
	Enable	01*	 %2402D01% *
Check digit transmission 2403	Disable	00*	 %2403D00% *
	Enable	01	 %2403D01%
Max. code length 2404	00-99	00-99	
		00*	 %2404D00% *
Min. code length 2405	00-99	00-99	
		01*	 %2405D01% *
Code ID setting 2406	00-FF ₁₆ (ASCII)	00-FF ₁₆	
		<U>*	 %2406H55% *
Insert group selection 2407	00-66	00-66	
		00*	 %2407D00% *



%%%END END

3-23 China Post

Read:

Format









11 Data digits

Max. /Min. code length: Refer to **Max./Min. code length** of “*3-11 Code 39 (Code 32, Trioptic Code 39)*”.

The code length of China Post is 11.

Code ID setting: Refer to **Code ID setting** of “*3-6 UPC-A*”.

Insertion group selection: Refer to **Insertion group selection** of “*3-6 UPC-A*”.

Multiple-scan setting			Single-scan setting
Option barcode	Option	Alpha. entry	
Read  2601	Disable	00	 %2601D00%
	Enable	01*	 %2601D01% *
Max. code length  2604	00-99	00-99	
		11*	 %2604D11% *
Min. code length  2605	00-99	00-99	
		11*	 %2605D11% *
Code ID setting  2606	00-FF ₁₆ (ASCII)	00-FF ₁₆	
		<T>*	 %2606H54% *
Insert group selection  2607	00-66	00-66	
		00*	 %2607D00% *

 %%%END END

3-24 China Finance

Read:

Format

10 Data digits

Max./Min. code length: Refer to **Max./Min. code length** of “*3-11 Code 39 (Code 32, Trioptic Code 39)*”.

Check digit verification: The check digit verification is optional.

Leading character 5/6/7/8/9 converted to A/B/C/D/E: By setting, leading character 5/6/7/8/9 can be converted to A/B/C/D/E.

Leading character assignment: By setting, only the barcode with the assigned leading character can be output.

Code ID setting: Refer to **Code ID setting** of “*3-6 UPC-A*”.

Insertion group selection: Refer to **Insertion group selection** of “*3-6 UPC-A*”.

Note: *This type of barcode is not Omni-directionally decodable. The encodable character set includes numeric 0 to 9. Among the symbol of 0 to 9, 0 and 2, 4 and 9, 5 and 8, 6 and 7, have the symmetrical pattern; the pattern of 1 and 3 is symmetrical.*



Multiple-scan setting			Single-scan setting
Option barcode	Option	Alpha. entry	
Read 3201	Disable	00	
	Enable	01*	*
Max. code length 3202	00-99	00-99	
		10*	*
Min. code length 3203	00-99	00-99	
		10*	*
Check digit verification 3204	Disable	00*	*
	Reserved	01	
Leading character 5/6/7/8/9 converted to A/B/C/D/E 3205	Disable	00	
	Enable	01*	*
	Only 5 converted to A	02	
	Only 6 converted to B	03	
	Only 7 converted to C	04	
	Only 8 converted to D	05	
	Only 9 converted to E	06	
Leading character assignment 3206	Disable	00	
	Assigned to 0	01*	*
	Assigned to 5(A)	02	
	Assigned to 6(B)	03	
	Assigned to 7(C)	04	



Multiple-scan setting			Single-scan setting
Option barcode	Option	Alpha. entry	
	Assigned to 8(D)	05	 %3206D05%
	Assigned to 9(E)	06	 %3206D06%
	Assigned to 1	07	 %3206D07%
	Assigned to 2	08	 %3206D08%
	Assigned to 3	09	 %3206D09%
	Assigned to 4	10	 %3206D10%
Code ID setting 3207	00-FF ₁₆ (ASCII)	00-FF ₁₆	
		<Y>*	 %3207H59% *
Insert group selection 3208	00-66	00-66	
		00*	 %3208D00% *



Laser Light Direction Setting: By scanning the barcode above, the decoding direction of the scanner's laser light is from left to right. By scanning the up-side-down barcode above, the decoding direction of the scanner's laser light is from right to left.

3-25 Telepen

Read:

Format

Start character (L)	Data digits (variable)	Check digit	End character (z)
---------------------	------------------------	-------------	-------------------

Check digit verification: The check digit verification is optional.

Check digit transmission: By setting Enable, check digit will be transmitted.

Max./Min. code length: Refer to **Max./Min. code length** of "*3-11 Code 39 (Code 32, Trioptic Code 39)*".

Code ID setting: Refer to **Code ID setting** of "*3-6 UPC-A*".

Insertion group selection: Refer to **Insertion group selection** of "*3-6 UPC-A*".

Encode character set type: Two options. Same Telepen symbol, with different option, is associated with different data output.

Alphanumeric- Supports both letters and numbers within the data source.

Numeric- Supports only numbers within the data source and ignores all letters.



%SETUP SETUP

Multiple-scan setting			Single-scan setting
Option barcode	Option	Alpha. entry	
Read 3501	Disable	00	 %3501D00%
	Enable	01*	 %3501D01% *
Check digit verification 3502	Disable	00	 %3502D00%
	Enable	01*	 %3502D01% *
Check digit transmission 3503	Disable	00*	 %3503D00% *
	Enable	01	 %3503D01%
Max. code length 3504	00-99	00-99	
		00*	 %3504D00% *
Min. code length 3505	00-99	00-99	
		01*	 %3505D01% *
Code ID setting 3506	00-FF ₁₆	00-FF ₁₆	
		P*	 %3506H50% *
Insertion group selection 3507	00-66	00-66	
		00*	 %3507D00% *
Encode character set type 3508	Alphanumeric	00*	 %3508D00% *
	Numeric	01	 %3508D01%



%%%END END

3-26 GS1 DataBar (GS1 DataBar Truncated)

GS1 DataBar Truncated is structured and encoded as the same as the standard GS1 DataBar format, except its height is reduced to a 13 modules minimum; while GS1 DataBar should have a height greater than or equal to 33 modules.

Read:

Format

16 Data digits

Code ID setting: Refer to Code ID setting of “[3-6 UPC-A](#)”.

Insertion group selection: Refer to Insertion group selection of “[3-6 UPC-A](#)”.

Conversion:

UCC/EAN 128- Refer to Code ID transmission of “[3-31 String transmission](#)”,]Cm will be identified as AIM ID.

UPC-A or EAN-13- Barcode beginning with a single zero as the first digit has the leading “010” stripped and the barcode reported as EAN-13. Barcode beginning with two or more zeros but not six zeros has the leading “0100” stripped and the barcode reported as UPC-A.

Multiple-scan setting			Single-scan setting
Option barcode	Option	Alpha. entry	
 %SETUP SETUP  2701	Disable	00	 %2701D00%
	Enable	01*	 %2701D01% *
 Code ID setting 2702	00-FF ₁₆ (ASCII)	00-FF ₁₆	
		<R >*	 %2702H52% *
 Insert group selection 2703	00-66	00-66	
		00*	 %2703D00% *
 Conversion 2704	None	00*	 %2704D00% *
	UCC/EAN 128	01	 %2704D01%
	UPC-A or EAN-13	02	 %2704D02%
 %%%END END			

3-27 GS1 DataBar Limited

Read:

Format

16 Data digits







Code ID setting: Refer to **Code ID setting** of “3-6 UPC-A”.

Insertion group selection: Refer to **Insertion group selection** of “3-6 UPC-A”.

Conversion: Refer to **Conversion** of “3-26 GS1 DataBar (GS1 DataBar Truncated)”.



%SETUP SETUP

Multiple-scan setting			Single-scan setting
Option barcode	Option	Alpha. entry	
Read  2801	Disable	00	 %2801D00%
	Enable	01*	 %2801D01% *
Code ID setting  2802	00-FF ₁₆ (ASCII)	00-FF ₁₆	
		<R >*	 %2802H52% *
Insert group selection  2803	00-66	00-66	
		00*	 %2803D00% *
Conversion  2804	None	00*	 %2804D00% *
	UCC/EAN 128	01	 %2804D01%
	UPC-A or EAN-13	02	 %2804D02%



%%%END END

3-28 GS1 DataBar Expanded

Read:

Format

Data characters (variable)















Code ID setting: Refer to Code ID setting of “*3-6 UPC-A*”.

Insertion group selection: Refer to Insertion group selection of “*3-6 UPC-A*”.

Conversion:

UCC/EAN 128- Refer to Code ID transmission of “*3-31 String transmission*”,]Cm will be identified as AIM ID.



Multiple-scan setting			Single-scan setting
Option barcode	Option	Alpha. entry	
Read  2901	Disable	00	 %2901D00%
	Enable	01*	 %2901D01% *
Max. code length  2902	00-99	00-99	
		00*	 %2902D00% *
Min. code length  2903	00-99	00-99	
		01*	 %2903D01% *
Code ID setting  2904	00-FF ₁₆ (ASCII)	00-FF ₁₆	
		<R >*	 %2904H52% *
Insert group selection  2905	00-66	00-66	
		00*	 %2905D00% *
Conversion  2906	None	00*	 %2906D00% *
	UCC/EAN 128	01	 %2906D01%



3-29 G1-G6 & FN1 substitution string setting

Format of barcode data transmission

Prefix	Code name	Preamble	Code ID	Code length	Code data	Code ID	Postamble	Suffix
--------	-----------	----------	---------	-------------	-----------	---------	-----------	--------

Suffix string setting: The <enter> key is represented in different ASCII when it is applied by different OS. For a Windows/DOS OS, <enter> is represented as < CR ><LF> (0x0D 0x0A); for an Apple MAC OS, <enter> is represented as <CR> (0x0D); for a Linux/Unix OS, <enter> is represented as <LF> (0x0A).

Prefix/Suffix string setting & Preamble/Postamble string setting:

They are appended to the data automatically when a barcode is decoded.

Example: Add a symbol of "\$" as a prefix for all symbols.

Steps:

- 1) Use the ASCII table to find the value of \$→24.
- 2) Scan **SETUP** and **Prefix string setting** barcode.
- 3) Scan **2** and **4** from the barcode on the foldout back page.
- 4) Scan **END** barcode.
- 5) Refer to section "[3-31 String transmission](#)", set **Prefix transmission** to be Enable.

Scanning steps: Scan the following barcodes in order.



Insert G1/G2/G3/G4 string setting: The scanner offers 4 positions and 4 character strings to insert among the symbol.

Example: Set G1 string to be "AB".

Original code data	"1 2 3 4 5 6"
Output code data	"1 2 A B 3 4 5 6"

Steps:

- 1) Use the ASCII table to find the value of A→41, B→42.
- 2) Scan **SETUP** and **Insert G1 string setting** barcode "8005".
- 3) Scan **4, 1** and **4, 2** from the barcode on the foldout back page.
- 4) Scan **END** barcode.
- 5) Refer to the chapter of "[3-30 G1-G4 string position & Code ID position](#)".
- 6) Refer to the chapter of "[3-4 Scan mode & some global settings](#)".



Testing barcode:



FN1 substitution string setting: The FN1 character (0x1D) in an UCC/EAN128 barcode, or a Code 128 barcode, or a GS1 DataBar barcode can be substituted with a defined string.

Truncate leading G5 string setting: By setting, a defined leading character or string can be truncated. Also a single character can be un-defined.

Repeat of a G5 character setting: While G5 is set as a single defined/un-defined character, G5 can also be set to be repeated. This setting is ignored when the truncate number is more than the barcode data characters. The option of “FF” for this setting is not active while the option of **Truncate leading G5 string setting** is “00”.

Example: Truncate all leading zeros for all symbols.

Original code data	“0 0 0 1 2 3 4 5 6”
Output code data	“1 2 3 4 5 6”

Steps: scan the following data in order.



Testing barcode:



Truncate ending G6 string setting: By setting, a defined ending character or string can be truncated. Also a single character can be un-defined.

Repeat of a G6 character setting: While G5 is set as a single defined/un-defined character, G6 can also be set to be repeated. This setting is ignored when the truncate number is more than the barcode data characters. The option of “FF” for this setting is not active while the option of **Truncate ending G6 string setting** is “00”.

Single character C1/C2 replacement: By setting, a defined character in the data string can be replaced by another defined character. The C1 and C2 replacement are applied simultaneously.

Example: Replace all the “A” character in a data string to be “B” character.

Original code data	“1 2 3 A 5 A”
Output code data	“1 2 3 B 5 B”

Steps: scan the following barcodes in order. The ASCII value for “A” is 41, and the ASCII value for “B” is 42.

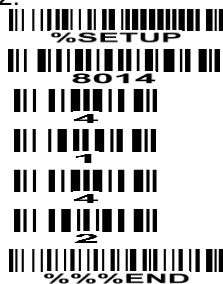

Testing barcode:





%SETUP SETUP

Multiple-scan setting			Single-scan setting
Option barcode	Option	Alpha. entry	
Prefix string setting  8001	0-22 characters	00-FF ₁₆	 %8001H00% *
	None	00*	
Suffix string setting  8002	0-22 characters	00-FF ₁₆	
	<ENTER>	0D0A*	
Preamble string setting  8003	0-22 characters	00-FF ₁₆	 %8003H00% *
	None	00*	
Postamble string setting  8004	0-22 characters	00-FF ₁₆	 %8004H00% *
	None	00*	
Insert G1 string setting  8005	0-22 characters	00-FF ₁₆	 %8005H00% *
	None	00*	
Insert G2 string setting  8006	0-22 characters	00-FF ₁₆	 %8006H00% *
	None	00*	
Insert G3 string setting  8007	0-22 characters	00-FF ₁₆	 %8007H00% *
	None	00*	
Insert G4 string setting  8008	0-22 characters	00-FF ₁₆	 %8008H00% *
	None	00*	
FN1 substitution string setting  8009	0-4 characters	00-FF ₁₆	 %8009H20% *
	<SP>	20*	
Truncate leading G5 string setting  8010	A un-defined character	00	 %8010H00%
	1-22 defined characters	01-7F ₁₆	



Multiple-scan setting			Single-scan setting
Option barcode	Option	Alpha. entry	
	<0>	30*	%8010H30% *
Repeat of a G5 character setting 8011	Once	01*	%8011H01% *
	Defined times	01-22	
	Un-defined times (All)	FF	%8011HFF%
Truncate ending G6 string setting 8012	A un-defined character	00	%8012H00%
	1-22 defined characters	01-7F ₁₆	
	<0>	30*	%8012H30% *
Repeat of a G6 character setting 8013	Once	01*	%8013H01% *
	Defined times	01-22	
	Un-defined times (All)	FF	%8013HFF%
Single character C1 replacement 8014	<0000>	0000*	
		0000-FFFF ₁₆	
Single character C2 replacement 8015	<0000>	0000*	
		0000-FFFF ₁₆	



3-30 G1-G4 string position & Code ID position

Format of barcode data transmission

Prefix	Code name	Preamble	Code ID	Code length	Code data	Code ID	Postamble	Suffix
--------	-----------	----------	---------	-------------	-----------	---------	-----------	--------

Insert G1/G2/G3/G4 string position: The scanner offers 4 positions to insert strings among the symbol. In case of the insertion position is greater than the length of the symbol, the insertion of string is not effective.

Code ID position: It is allowed to select different positions of code ID placement.

			
Multiple-scan setting			Single-scan setting
Option barcode	Option	Alpha. entry	
Insert G1 string position  8101	00-99	00-99	
		00*	 %8101D00%*
Insert G2 string position  8102	00-99	00-99	
		00*	 %8102D00%*
Insert G3 string position  8103	00-99	00-99	
		00*	 %8103D00%*
Insert G4 string position  8104	00-99	00-99	
		00*	 %8104D00%*
Code ID position  8105	Before code data	00*	 %8105D00%*
	After code data	01	 %8105D01%
			

3-31 String transmission

Format of barcode data transmission

Prefix	Code name	Preamble	Code ID	Code length	Code data	Code ID	Postamble	Suffix
--------	-----------	----------	---------	-------------	-----------	---------	-----------	--------

Prefix transmission: By setting Enable, prefix will be appended before the data transmitted.

Suffix transmission: By setting Enable, suffix will be appended after the data is transmitted.

Code name transmission: By setting Enable, code name will be transmitted before code data.

Preamble transmission: By setting Enable, preamble will be appended before the data transmitted.

Postamble transmission: By setting Enable, postamble will be appended after the data is transmitted.

Code ID transmission: Code ID can be transmitted in the format of either Proprietary ID or AIM ID. Refer to the chapter of "[1-3 Default setting for various types of barcode](#)".

Code length transmission: The length of code data string can be transmitted before the code data when Enable is selected. The length is represented by a number with two digits.

Case conversion: The characters within code data or the whole output string can be set in either upper case or lower case.

FN1 substitution transmission: The scanner supports a FN1 substitution feature for keyboard wedge, USB and RS-232 interface. The replacement string of FN1 can be chosen by user (see chapter of "[3-29 G1-G6 & FN1 substitution string setting](#)").

All-non-printable-character string transmission with string setting: By setting enable, all string settings, e.g. [Preamble transmission](#) or [Insert G1 string setting](#), are active for an all-non-printable-character string. Here a non-printable character means a character with ASCII value between 0x00 to 0x1F.

Transmit the first N data characters only: The scanner supports to only transmit the first N data characters of a barcode. The number of N can be set as a digit between 1 and 99.

Transmit the last N data characters only: The scanner supports to only transmit the last N data characters of a barcode. The number of N can be set as a digit between 1 and 99.



%SETUP SETUP

Multiple-scan setting			Single-scan setting
Option barcode	Option	Alpha. entry	
Prefix transmission  8201	Disable	00*	 %8201D00% *
	Enable	01	 %8201D01%
Suffix transmission  8202	Disable	00	 %8202D00%
	Enable	01*	 %8202D01% *
Code name transmission  8203	Disable	00*	 %8203D00% *
	Enable	01	 %8203D01%
Preamble transmission  8204	Disable	00*	 %8204D00% *
	Enable	01	 %8204D01%
Postamble transmission  8205	Disable	00*	 %8205D00% *
	Enable	01	 %8205D01%
Code ID transmission  8206	Disable	00*	 %8206D00% *
	Proprietary ID	01	 %8206D01%
	AIM ID	02	 %8206D02%
Code length transmission  8207	Disable	00*	 %8207D00% *
	Enable	01	 %8207D01%
Case conversion  8208	Disable	00*	 %8208D00% *
	Upper (data only)	01	 %8208D01%
	Lower (data only)	02	 %8208D02%
	Upper (whole string)	03	 %8208D03%



%SETUP SETUP

Multiple-scan setting			Single-scan setting
Option barcode	Option	Alpha. entry	
	Lower (whole string)	04	%8208D04%
FN1 substitution transmission 8209	Disable	00*	%8209D00% *
	Keyboard wedge /USB	01	%8209D01%
	RS-232	02	%8209D02%
	Keyboard wedge / USB / RS-232	03	%8209D03%
All-non-printable-character string transmission with string setting 8210	Disable	00*	%8210D00% *
	Enable	01	%8210D01%
Transmit the first N data characters only 8211	All	99*	%8211D99%
	01-99	01-99	
Transmit the last N data characters only 8212	All	99*	%8212D99% *
	01-99	01-99	



%%END END

4 Operate the scanner by command via UART or USB virtual UART

Note:

- 1- The information in this chapter is provided for the scanner with RS232 cable or USB cable.
- 2- If the scanner is with USB cable, the setting of **USB device type** must be set as "USB virtual COM".
Please refer to chapter of "[3-3 USB interface](#)".
- 3-Please read the chapter of "[3-4 Scan mode & some global settings](#)" about the setting of **Scanning mode** in details.

UART parameter should be set as below:

- (1) Baud rate: 300bps ~ 115200 bps;
- (2) Data bits: 8 bits;
- (3) Stop bit: 1 bit/2bit;
- (4) Parity check bit: None/Odd/Even;
- (5) Flow control: None, RTS/CTS, ACK/NAK.

Table 4-1 lists the commands that the scanner supports. The command is sent in data package format. The data package format refers to "[4-1 Command data packet format](#)". The specific operation of each command refers to the corresponding section.

Table 4-1 Command table

Num	Command name	Operation code	Description
1	CMD_ACK	0x59('Y')	ACK
2	CMD_NAK	0x4E('N')	NAK
3	DECODE_DATA	0x50('P')	Packet Decode data
4	REQUEST_REVISION	0x56('V')	Request scanner software revision
5	REPLY_REVISION	0x52('R')	Reply scanner software revision
6	START_DECODE	0x53('S')	Start decoding
7	STOP_DECODE	0x45('E')	Stop decoding
8	PARAM_DEFAULT	0x25('%')	Recover default parameter setting
9	PARAM_REQUEST	0x3F('?')	Parameter requesting. Support to check some types of parameter property (max value, min value, current permanent setting, default setting and so on) .
10	PARAM_SEND	0x23('#')	Parameter transmission. The host asks the scanner to change one or more parameters' setting.
11	UPGRADE	0x55('U')	Upgrade loader or application
12	CMD_RESTART	0x5e('^')	Restart the scanner
13	GOOD_READ_START		Start to decode to identify whether the barcode is readable or not
14	GOOD_READ_STOP		Stop executing GOOD_READ_START command

Note:

When executes the **START_DECODE** command, it only can be interrupted by the **STOP_DECODE** command. And when executes the other commands, it can't be interrupted by any other commands.

4-1 Command data packet format

The general packet format is as following:

Length	Opcode	Status	Data	Checksum
--------	--------	--------	------	----------

Notice: Opcode is the abbreviation about Operation code.

Table 4-2 lists the descriptions of fields that occur in all messages. This description is repeated for each opcode. For messages that use the data field, the specific type of data is described in that field in later sections.

Table 4-2 Field descriptions

Field name	Type	Sub-Field	Description
Length	1 byte	Length	Length of message not including the check sum bytes. Maximum value is 0xFF.
Opcode	1 byte	See table 4-1 for details	Identifies the command being sent.
Status	Bit0	Retransmit	0 = First time packet is sent 1 = Subsequent transmission attempts
	Bit5-1	Parameter property (use for parameter requesting and parameter transmission)	
	Bit6	Change type (apply to parameter transmission)	0 = Temporary change 1 = Permanent change
	Bit7	Command source	1:Command is from the host. 0:Command is from the scanner
Data	Variable number of bytes	See individual sections for details	
Checksum	2 bytes	2's complement sum of message contents excluding checksum	Checksum of message formatted as High-Byte Low-Byte
<p>Note: The checksum is a 2 byte checksum and must be sent as High-Byte followed by Low-Byte. Checksum = 0x10000 – Length - Opcode - Status – Data.</p>			

4-2 CMD_ACK

Description: Positive acknowledgment of received packet.

Packet Format

Length	Opcode	Status	Checksum
0x03	0x59 (‘Y’)		

Field Descriptions

Table 4-3 Field Descriptions

Field name	Format	Size	Description
Length	Length of message (not including checksum).	1 byte	Length of Field
Opcode	0x59	1 byte	Identifies the command opcode type.
Status	Bit 0 : Retransmit Bit 1-6 : unused Bit 7: Command source	1 byte	Bit 0: Identifies the transmission status. Bit 7 : 1, Command is from the host. 0, Command is from the scanner. All unused bits must be set to 0.
Checksum	2's complement sum of message contents excluding checksum	2 bytes	Checksum of message

CMD_ACK message is sent to the UART packet transmitter when the received packet passes the checksum check and no negative acknowledgment conditions apply. If the data to be sent is in response to a command (e.g. REQUEST_REVISION), CMD_ACK message is not in need.

When ACK/NAK handshaking is disabled, the CMD_ACK message will not be sent.

It is not necessary to respond to a valid ACK or NAK message.

For example:

Length	Opcode	Status	Checksum
0x03	0x59	0x00	0xFF 0xA4

Host Requirements

The host must send a CMD_ACK or response data within the programmable **Host Serial Response Time-out** to acknowledge receipt of all messages, unless noted otherwise in the message description section. If the host sends data and does not receive a response within the programmable **Host Serial Response Time-out**, it resends the message (with the retransmit status bit set) before declaring a failure.

The host should limit the number of retries.

Scanner Requirements

The scanner must send a CMD_ACK or response data within the programmable **Host Serial Response Time-out** to acknowledge receipt of all messages, unless noted otherwise in the message description

section. If the scanner does not receive an ACK within this time period, it sends the previous message again. The scanner retries twice more (with the retransmit status bit set) before declaring a transmit error.

4-3 CMD_NAK

Description: Negative acknowledgment of received packet

Packet Format

Length	Opcode	Status	Cause	Checksum
0x04	0x4E (‘N’)			

Field Descriptions

Table 4-4 Field Descriptions

Field Name	Format	Size	Description
Length	Length of message (not including checksum).	1 Byte	Length Field
Opcode	0x4E	1 Byte	Identifies the opcode type.
Status	Bit 0 : Retransmit Bit 1-6 : Unused Bit 7: Command source	1 Byte	Bit 0: Identifies the transmission status. Bit 7 : 1, Command is from the host. 0, Command is from the scanner. All unused bits must be set to 0.
Cause	Reason code	1 Byte	Identifies the reason the NAK occurred: Bit 0 = busy, the scanner is executing a command. Bit 1 = (NAK_RESEND) Checksum failure. Bit 2 = (NAK_BAD_CONTEXT) Unexpected or Unknown message Bit 3 = (NAK_DENIED) Bit 4 = Reserved Bit 5 = Reserved Bit 6 = (NAK_NO_PARA) the parameters wishing to change do not exist Bit 7 = (NAK_OUT_OF_RANGE) the parameters wishing to change exceed the range
Checksum	2's complement sum of message contents excluding checksum.	2 Bytes	Checksum of message.

This message is sent when the received packet fails the checksum verification or some error occurred while handling the message. If the scanner received NAK within this time period, it sends the previous message again. The scanner retries twice before declaring a transmit error. The engine only resends a message twice. If the message is not sent successfully either time, the engine declares a transmit error

and issues transmit error beep.

✚ When ACK/NAK handshaking is disabled, the CMD_NAK message will not be sent.

✚ It is not necessary to respond to a valid ACK or NAK message.

For example:

Length	Opcode	Status	Cause	Checksum
0x04	0x4E	0x00	0x40 (the parameter wishing to change is not existed)	0xFF 0x6E

Table 4-5 describes NAK types supported by the scanner.

Table 4-5 Scanner-supported NAK types

NAK Type	Meaning	Receiver Action
NAK_RESEND	Checksum incorrect.	Ensure checksum is correct. Limit number of resends. Send packet again with resend bit set (with the retransmit status bit set).
NAK_NO_PARA	the parameter wishing to change is not existed	Do not send the same message again. Developer should ensure the proper message is sent.
NAK_OUT_OF_RANGE	the parameter wishing to change exceeds the range	
NAK_BAD_CONTEXT	Host does not recognize the opcode.	
NAK_DENIED	Host is unable to comply with the requested command (e.g., scanning mode setting is out of range).	

4-4 DECODE_DATA

Description: Decode data in UART packet format

Packet Format

Length	Opcode	Status	Decode Data	Checksum
	0x50 (‘P’)			

Field Descriptions

Table 4-6 Field Descriptions

Field Name	Format	Size	Description
Length	Length of message (not including checksum).	1 Byte	Length Field
Opcode	0x50	1 Byte	Identifies the opcode type.
Status	Bit 0 : Retransmit Bit 1-6 : Unused Bit 7: Command source	1 Byte	Bit 0: Identifies the transmission status. Bit 7: 1: Command is from the host. 0: Command is from the scanner. All unused bits must be set to 0.
Decode Data	<data>	Variable	The decoded data include prefix, suffix and so on, which is sent in ASCII format.
Checksum	2's complement sum of message contents excluding checksum.	2 Bytes	Checksum of message.

The scanner uses this opcode when data packet is selected to send decoded barcode data to the host. The decoded message is contained in the Decode Data field.

Host Requirements

If ACK/NAK handshaking is enabled, the host responds ACK to the scanner when received correct data packet.

Scanner Requirements

Decode data is sent in this format if decode data packet is selected via parameter. The host responds to this message with a CMD_ACK, if ACK/NAK handshaking is enabled.

For example: the decode result is “1234”, the data packet sent to host is as following.

Length	Opcode	Status	Decode Data	Checksum
0x07	0x50	0x00	0x31 0x32 0x33 0x34	0xFE 0xDF

Note: Checksum=0x10000-0x07-0x50-0x00-0x31-0x32-0x33-0x34=0xFEDF.

4-5 REQUEST_REVISION

Description: Request the software revision string from the engine

Packet Format

Length	Opcode	Status	Checksum
0x03	0x56 (‘V’)		

Field Descriptions

Table 4-7 Field Descriptions

Field Name	Format	Size	Description
Length	Length of message (not including checksum).	1 Byte	Length Field
Opcode	0x56	1 Byte	Identifies this opcode type.
Status	Bit 0 : Retransmit Bit 1-6 : Unused Bit 7: Command source	1 Byte	Bit 0: Identifies the transmission status. Bit 7: 1, Command is from the host. 0, Command is from the scanner. All unused bits must be set to 0.
Checksum	2's complement sum of message contents excluding checksum.	2 Bytes	Checksum of message.

For example:

Length	Opcode	Status	Checksum
0x03	0x56	0x80	0xFF 0x27

Host Requirements

The host sends this message to request revision information from the scanner. The scanner responds with REPLY_REVISION.

Scanner Requirements

The scanner sends its revision string to the host. See REPLY_REVISION for format.

4-6 REPLY_REVISION

Description: Reply to REQUEST_REVISION command with software revision string

Packet Format

Length	Opcode	Status	Revision	Checksum
	0x52 (‘R’)			

Field Descriptions

Table 4-8 Field Descriptions

Field Name	Format	Size	Description
Length	Length of message (not including checksum).	1 Byte	Length Field
Opcode	0x52	1 Byte	Identifies this opcode type.
Status	Bit 0 : Retransmit Bit 1-6 : Unused Bit 7: Command source	1 Byte	Bit 0: Identifies the transmission status. Bit 7: 1: Command is from the host. 0: Command is from the scanner All unused bits must be set to 0.
Revision	ASCII data	variable	Software revision in ASCII (* see following for details).
Checksum	2's complement sum of message contents excluding checksum.	2 Bytes	Checksum of message.

Host Requirements

None.

Scanner Requirements

*The scanner sends its Revision field data string to the host in the following format:

SW_REVISION<space>ENGINE_ID

Where:

SW_RIVISION is the version string including software information.

ENGINE_ID is always 0x1B, it presents the scanner ID information.

For example, if the SW_REVISION is “ES4200_App_V1.0.1”, the REPLY_REVISION message will be:

Length	Opcode	Status	Revision	Checksum
0x16	0x52	0x80	0x45 0x53 0x34 0x32 0x30 0x30 0x5F 0x41 0x70 0x70 0x5F 0x56 0x31 0x2E 0x30 0x2E 0x31 0x20 0x1B	0xFC 0x64

4-7 START_DECODE

Description: Ask the scanner to attempt to decode a barcode

Packet Format

Length	Opcode	Status	Checksum
0x03	0x53 (‘S’)		

Field Descriptions

Table 4-9 Field Descriptions

Field Name	Format	Size	Description
Length	Length of message (not including checksum).	1 Byte	Length Field
Opcode	0x53	1 Byte	Identifies this opcode type.
Status	Bit 0 : Retransmit Bit 1-6 : Unused Bit 7: Command source	1 Byte	Bit 0: Identifies the transmission status. Bit 7: 1, Command is from the host. 0, Command is from the scanner All unused bits must be set to 0.
Checksum	2's complement sum of message contents excluding checksum.	2 Bytes	Checksum of message.

This command asks the scanner to start a scan and a decode session. The decode session ends with a successful decode, or a scan session time-out, or a **STOP_DECODE** command.

For example:

Length	Opcode	Status	Checksum
0x03	0x53	0x80	0xFF 0x2A

Host Requirements

None.

Scanner Requirements

The scanner must decode a barcode in any mode, when received the START_DECODE command.

4-8 STOP_DECODE

Description: Ask scanner to abort a decode attempt

Packet Format

Length	Opcode	Status	Checksum
0x04	0x45 (‘E’)		

Field Descriptions

Table 4-10 Field Descriptions

Field Name	Format	Size	Description
Length	Length of message (not including checksum).	1 Byte	Length Field
Opcode	0x45	1 Byte	Identifies this opcode type.
Status	Bit 0 : Retransmit Bit 1-6 : Unused Bit 7: Command source	1 Byte	Bit 0: Identifies the transmission status. Bit 7: 1, Command is from the host. 0, Command is from the scanner. All unused bits must be set to 0.
Checksum	2's complement sum of message contents excluding checksum.	2 Bytes	Checksum of message.

This command asks the scanner to stop a scan and a decode attempt.

For example:

Length	Opcode	Status	Checksum
0x03	0x45	0x80	0xFF 0x38

Host Requirements

None.

Scanner Requirements

The scanner responds with a ACK or NAK and abort the decode operation, when a STOP_DECODE command received, if ACK/NAK handshaking is enabled.

4-9 PARAM_DEFAULTS

Description: Set the parameters to factory default values

Packet Format

Length	Opcode	Status	Setting type	Checksum
0x04	0x25 (‘%’)			

Field Descriptions

Table 4-11 Field Descriptions

Field Name	Format	Size	Description
Length	Length of message (not including checksum).	1 Byte	Length Field
Opcode	0x25	1 Byte	Identifies this opcode type.
Status	Bit 0 : Retransmit Bit 1-6 : Unused Bit 7: Command source	1 Byte	Bit 0: Identifies the transmission status. Bit 7: 1: Command is from the host. 0: Command is from the scanner All unused bits must be set to 0.
Setting type	Default setting type	1 Byte	0-255. 0: Default setting 0 (Mindeo standard) 1: Default setting 1 2: Default setting 2 others: Reserved
Checksum	2's complement sum of message contents excluding checksum.	2 Bytes	Checksum of message.

For example: return all parameters to the factory default setting values.

Length	Opcode	Status	Setting type	Checksum
0x04	0x25	0x80	0x00	0xFF 0x57

Host Requirements

The host sends this command to reset the scanner's parameter settings to the factory default values.

Scanner Requirements

The scanner responds with a ACK or NAK and return all parameters to the factory default setting values (excluding scanning mode parameters) if ACK/NAK handshaking is enabled, when a PARAM_DEFAULTS command received. The command has the same effect with the **Default Value Initialization barcode** on the scanner.

4-10 PARAM_REQUEST

Description: Request values of selected parameters

Packet Format

Length	Opcode	Status	Option code	Checksum
	0x3F (?)			

Field Descriptions

Table 4-12 Field Descriptions

Field Name	Format	Size	Description
Length	Length of message (not including checksum).	1 Byte	Length Field
Opcode	0x3F	1 Byte	Identifies this opcode type.
Status	Bit 0 : Retransmit Bit 1-5 : Query property of the parameter Bit 6 : Unused Bit 7: Command source	1 Byte	Bit 0: Identifies the transmission status. Bit1-5 : Control querying the property of parameter 0, Query maximum value of the parameter 1, Query minimum value of the parameter 2, Query permanent setting value of the parameter 3, Query temporary setting value of the parameter 4, Query the default value of the parameter 5-15,Reserved. Bit 6: Reserved to be 0. Bit 7: 1, Command is from the host.
Option code	ASCII value of the option code	Variable	Each option code has 4 bytes, the scanner can query several parameters. Parameter 1, Parameter 2...
Checksum	2's complement sum of message contents excluding checksum.	2 Bytes	Checksum of message.

The host uses this message to request selected parameters from the scanner.

Host Requirements

The host requests the scanner's current values for specific parameters by listing the parameter codes in the Request Data field. If the host asks for a parameter value which is not supported by the scanner, the

scanner responses NAK.

The scanner's response to this command is PARAM_SEND, not ACK. Depending on the time-out setting, and the number of parameters requested, this reply may fall outside the programmable **Host Serial Response Time-out**. If this occurs, this is not a time-out error. To compensate, increase the time-out.

Scanner Requirements

When the scanner receives this message, it processes the information by formatting a PARAM_SEND message containing all requested parameters supported and their values. The programmable **Host Serial Response Time-out** can be exceeded when processing this message, depending on the time-out set and the number of parameters requested.

For example: the value of scanner parameter "0301" is 1, when host query information of the parameter "0301", the PARAM-REQUEST sent by host is as following:

Length	Opcode	Status	Parameter code	Checksum
0x07	0x3F (?)	0x80	0x30 0x33 0x30 0x31 ('0' '3' '0' '1')	0xFE 0x76

the PARAM-SEND responded by scanner is as following:

Length	Opcode	Status	Parameter code	Data type	parameter	Checksum
0x0A	0x23 (#)	0x00	0x30 0x33 0x30 0x31 ('0' '3' '0' '1')	0x44 'D'	0x30 0x31 ('0' '1')	0xFE 0x6A

4-11 PARAM_SEND

Description: the command performs two optional operations:

- 1) The scanner respond to a PARAM_REQUEST.
- 2)The host demand scanner to change particular parameter values.

Packet Format

Length	Opcode	Status	Option code	Data type	Parameter value	...	Checksum
	0x23 (#)						

Field Descriptions

Table 4-13 Field Descriptions

Field Name	Format	Size	Description
Length	Length of message (not including checksum).	1 Byte	Length Field
Opcode	0x23	1 Byte	Identifies this opcode type.
Status	Bit 0: Retransmit Bit 5-1: Query property of the parameter Bit 6: Change Type Bit 7: Command source	1 Byte	Bit0 : Identifies the transmission status. Bit5-1 : Property of the parameter 0 , Max value 1 , Min value 2 , Permanent value 3 , Temporary value 4 , Default value 5-15 , Reserve Bit6 : 1 , Permanently change 0 , Temporarily change Bit7: 1, Host sends, requesting scanner change parameter. 0, scanner sends, replying PARAM_REQUEST command.
Option Code	ASCII value of the option code	4 Bytes	4 bytes for each option code
Data type	0x48/0x44/0x53	1 Byte	ASCII value of character'H' , 'D' or'S' 'H': Parameter value is in hexadecimal type, 2 bytes. 'D': Parameter value is in decimal type, 2 bytes. 'S': Parameter value is in character string type,

Field Name	Format	Size	Description
			ending with '\0', 1 to 23 bytes.
Parameter Value		Variable	1 to 23 bytes
...		Variable	Next parameter setting (option code , data type , parameter value)
Checksum	2's complement sum of message contents excluding checksum.	2 Bytes	Checksum of message.

This message is sent by the scanner in response to the PARAM_REQUEST message, or by the host to change the scanner's parameter values.

Example: to set parameter Flow control to be **None** (see section "[3-2 RS-232 interface](#)").

Length	Opcode	Status	Parameter code	Data type	Parameter value	Checksum
0x0A	0x23	0xC0	0x30 0x33 0x30 0x31 ('0' '3' '0' '1')	0x44 'D'	0x30 0x30 ('0' '0')	0xFD 0xAB

Host Requirements

The host transmits this message to change the scanner's parameters. Be sure the Change Type bit (bit 6 of the Status byte) in the Status field is set as desired.

Scanner Requirements

✚ When the scanner receives a PARAM_SEND, it interprets and stores the parameters, then ACKs the command (if ACK/NAK handshaking is enabled). These parameters are stored permanently only if the Change Type (bit 6 of the Status byte) is set to 1. Frequent permanent changes are not recommended due to the limited write-cycles of flash memory. If bit 6 is set to 0 the changes are temporary, and are lost when the engine is powered down.

If the scanner changes the parameter, it issues the requested beep sequence and stores the requested parameter values.

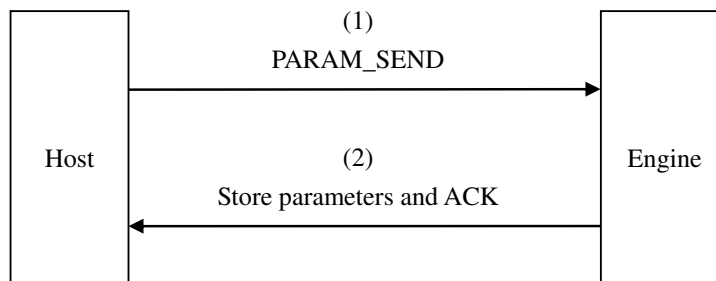

Figure 4-1 Host demands scanner to change parameter

✚ The scanner issues a PARAM_SEND in response to a PARAM_REQUEST from the host. It responds to the PARAM_REQUEST message by sending all supported parameter values. No value

is sent for any unsupported parameter. If none of the requested values is supported, the scanner responds to the host with NAK.

- ✚ When the scanner sends PARAM_SEND message, the Change Type bit (bit 6 of Status byte) can be ignored.

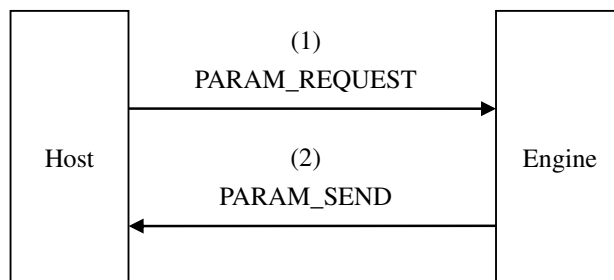

Figure 4-2 Host queries scanner's parameter

4-12 UPGRADE

Description: the command demands the scanner to upgrade its firmware.

Packet Format

Length	Opcode	Status	Data	Checksum
0x07	0x55 (‘U’)			

Field Descriptions

Table 4-14 Field Descriptions

Field Name	Format	Size	Description
Length	Length of message (not including checksum).	1 Byte	Length Field
Opcode	0x55	1 Byte	Identifies this opcode type.
Status	Bit0 : Retransmit Bit7: Command source	1 Byte	Bit 0: Identifies the transmission status. Bit 7: 1: Command is from the host.
Data	The data supported: 1)0xAAAA5555 2)0x12345678 3)0x87654321	4 Bytes	The scanner receives 3 commands continually, which contain the content of data 1), data 2), data 3), then the scanner starts to upgrade its LOADER or APPLICATION by the upgrade software.
Checksum	2's complement sum of message contents excluding checksum.	2 Bytes	Checksum of message.

For example: the scanner gets into upgraded state by receiving the data packets as following orderly:

NO.	Length	Opcode	Status	Data	Checksum
1	0x07	0x55	0x80	0xAA 0xAA 0x55 0x55	0xFD 0x26
2	0x07	0x55	0x80	0x12 0x34 0x56 0x78	0xFE 0x10
3	0x07	0x55	0x80	0x87 0x65 0x43 0x21	0xFD 0xD4

Host Requirements

The host sends 3 commands to the scanner orderly, which contains the content required, the scanner is demanded to upgrade its firmware.

Scanner Requirements

If ACK/NAK handshaking is enabled, the scanner responds with ACK or NAK when a command received. while the scanner receives the command orderly (1->2->3), it upgrades its firmware.

4-13 RESTART

Description: the command demands the scanner to restart.

Packet Format

Length	Opcode	Status	Checksum
0x03	0x5E ('^')		

Field Descriptions

Table 4-15 Field Descriptions

Field Name	Format	Size	Description
Length	Length of message (not including checksum).	1 Byte	Length Field
Opcode	0x5E	1 Byte	Identifies this opcode type.
Status	Bit0 : Retransmit Bit7: Command source	1 Byte	Bit0 : Identifies the transmission status. Bit7: 1, Command source.
Checksum	2's complement sum of message contents excluding checksum.	2 Bytes	Checksum of message.

For example: the host sends the command to restart the scanner.

Length	Opcode	Status	Checksum
0x03	0x5E	0x80	0xFF 0x28

Host Requirements

The host sends RESTART to the scanner, which makes scanner restarted.

Scanner Requirements

If ACK/NAK handshaking is enabled, the scanner responds with ACK or NAK and restart, when the RESTART received.

4-14 GOOD_READ_START

Description: the command demands the scanner to start to decode to identify whether the barcode is readable or not.

Packet Format

<SYN>	<T>	<CR>
0x16	0x54	0x0D

Host Requirements

The host sends GOOD_READ_START to the scanner to identify the barcode is readable or not.

Scanner Requirements

If ACK/NAK handshaking is enabled, the scanner responds with ACK or NAK and then start to decode, when it receives the GOOD_READ_START command. Otherwise, the scanner will start to decode directly.

If decodes successfully, the scanner turns off light source and replies "<STX><]><CR><LF>".

<STX>	<]>	<CR>	<LF>
0x02	0x5D	0x0D	0x0A

When there is no barcode decoded successfully after the Stand-by duration elapsed, the scanner turns off light source and replies "<STX><CAN><CR><LF>".

<STX>	<CAN>	<CR>	<LF>
0x02	0x18	0x0D	0x0A

Note: Only when the Scan mode is Good-read identification, this command is valid.

4-15 GOOD_READ_STOP

Description: the command demands the scanner to stop executing GOOD_READ_START command.

Packet Format

<SYN>	<U>	<CR>
0x16	0x55	0x0D

Host Requirements

The host sends GOOD_READ_STOP command to the scanner to stop executing GOOD_READ_START command.

Scanner Requirements

If ACK/NAK handshaking is enabled, the scanner responds with ACK or NAK and then stops decoding, when it receives the GOOD_READ_STOP command. Otherwise, the scanner will stop decoding directly.

Note: Only when the Scan mode is Good-read identification, this command is valid.

4-16 The control of timing conflict

If the scanner has started the data transmission, while the host sends commands to the scanner, once the scanner receives complete command, it stops its data transmission to respond the host command, and then restart the terminated data transmission, due to the data transmitted in packet format, the host can accurately separate from the received data: 1) response information. 2) information about transmitted data originally.

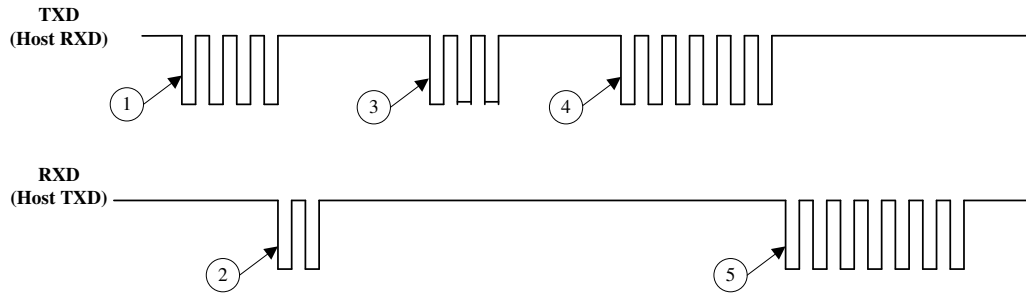

1. The scanner starts to send data
2. The host interrupts the scanner sending data and sends PARAM_REQUEST command
3. The scanner sends PARAM_SEND data packet to reply host's PARAM_REQUEST command
4. The scanner resends the interrupting data (all data is resent)
6. The host sends ACK

Figure 4-3 Timing control

5 Troubleshooting

1	Problem	Nothing happens when you follow the operating instruction, or the scanner displays erratic behavior.
	Possible causes and possible solution	<ol style="list-style-type: none"> 1) No power to the scanner. Check the system power. Ensure the power supply is connected. 2) The cable connection is incorrect. Connect the cable again.
2	Problem	Scanned data is incorrectly displayed on the host.
	Possible causes and possible solutions	<ol style="list-style-type: none"> 1) The cable connection is incorrect. Connect the cable again. 2) For a USB-HID keyboard or a keyboard wedge configuration, ensure the system is programmed for the correct keyboard type and language, and the CAPS LOCK key is in the correct state.
3	Problem	Laser comes on, but the scanner does not decode.
	Possible causes and possible solutions	<ol style="list-style-type: none"> 1) Barcode symbol is unreadable. Check the symbol to make sure it is not defaced. Try scanning test symbols of the same barcode type. 2) Scanner is not programmed for the correct barcode type. Be sure the scanner is programmed to read the type of barcode you are scanning. 3) Distance between scanner and barcode is incorrect. Move the scanner closer to or further from the barcode.
4	Problem	Other circumstances.
	Possible causes and possible solutions	<ol style="list-style-type: none"> 1) Shutdown the device, and correctly connect the scanner to the device. Then start up the device and test. 2) If the problem is still unsolved, contact your distributor or the manufactory support centre.

6 Maintenance

Cleaning the exit window is the only maintenance required. A dirty window may affect scanning accuracy.

1. Do not allow any abrasive material to touch the window.
2. Remove any dirt particles with a damp cloth.
3. Wipe the window using a tissue moistened with water.
4. Do not spray water or other cleaning liquids directly into the window.

Use a piece of soft and dry cloth when cleaning the scanner.

7 Barcode representing non-printable character

Notes to make the following barcode:

1. According to different barcode printing software, the method of printing following barcode is different.
2. If using CODESOFT software, firstly read the information through “Help→Index→Code128→Special input syntax”. Also refer to ASCII table. For example, if we wish to make “F1” barcode, select “code128”, then select “CODE A” type, and input “{DOC1}” as data.



Up ↑



Down ↓



Left ←



Right →



Page Up



Page Down



Backspace



Tab



Home



End



Enter



Insert



Delete



F1



F2



F3



F4



F5



F6



F7



F8



F9



F10



Esc



F11



F12

8 ASCII Table

	USB		RS-232	
H L	0	1	0	1
0	Null		NUL	DLE
1	Up	F1	SOH	DC1
2	Down	F2	STX	DC2
3	Left	F3	ETX	DC3
4	Right	F4	EOT	DC4
5	PgUp	F5	ENQ	NAK
6	PgDn	F6	ACK	SYN
7		F7	BEL	ETB
8	Bs	F8	BS	CAN
9	Tab	F9	HT	EM
A		F10	LF	SUB
B	Home	Esc	VT	ESC
C	End	F11	FF	FS
D	Enter	F12	CR	GS
E	Insert	Ctrl+	SO	RS
F	Delete	Alt+	SI	US

Note: the second and third columns are just used for USB interface in above table.

H L	2	3	4	5	6	7
0	SP	0	@	P	`	p
1	!	1	A	Q	a	q
2	“	2	B	R	b	r
3	#	3	C	S	c	s
4	\$	4	D	T	d	t
5	%	5	E	U	e	u
6	&	6	F	V	f	v
7	‘	7	G	W	g	w
8	(8	H	X	h	x
9)	9	I	Y	i	y
A	*	:	J	Z	j	z
B	+	;	K	[k	{
C	,	<	L	\	l	
D	-	=	M]	m	}
E	.	>	N	^	n	~
F	/	?	O	_	o	DEL

Example : ASCII “A” = “41”。

9 Test symbols

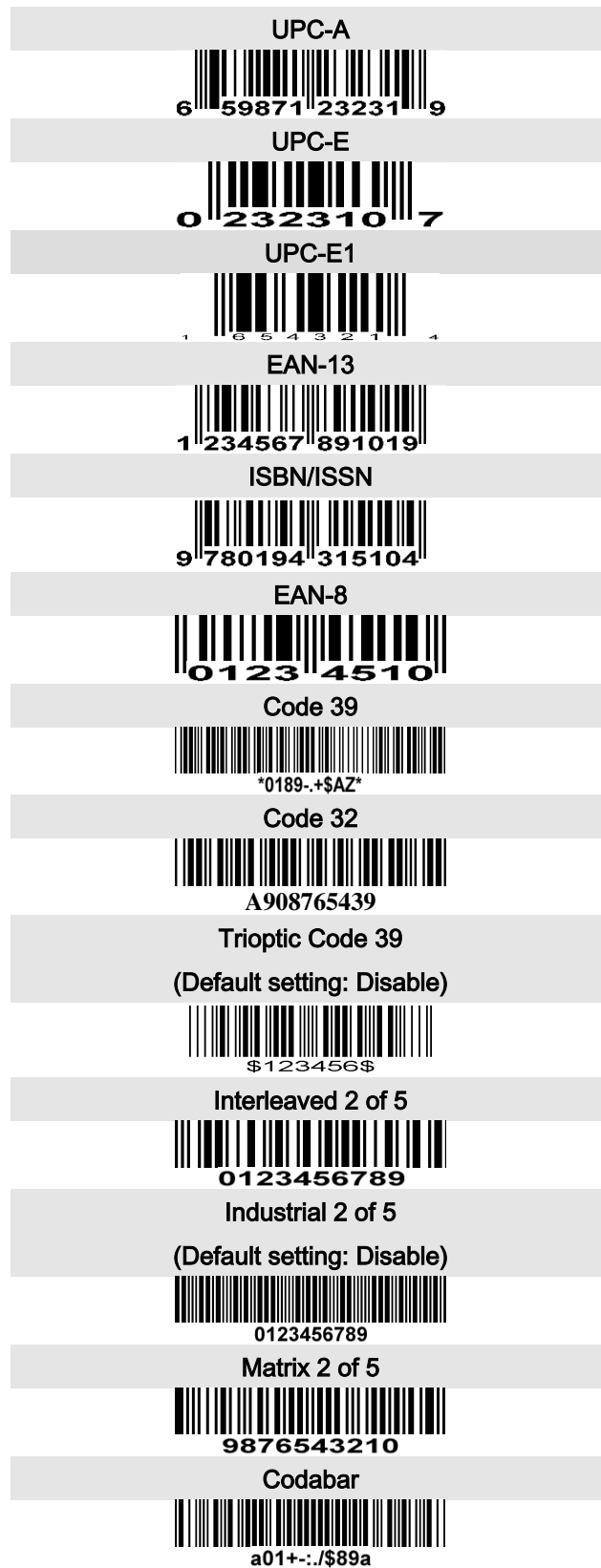

Test chart (continue)

Code 128

01AZ[+~*/]za98

UCC/EAN 128

01AZ[]+~az54

ISBT 128

=1234 56789

Code 93

01AZ+~/*az89

Code 11
(Default setting: Disable)

123456789-0

MSI/Plessey
(Default setting: Disable)

0123456789

UK/Plessey

01ABEF89

China Post

54 7896321 45

Telepen

_1234567z

GS1 DataBar (GS1 DataBar Truncated)

(01) 12345678901231

GS1 DataBar Limited

(01) 1 2345678 90126 2

GS1 DataBar Expanded

Ab_09+yZ

10 Return default parameters & firmware version



WARNING: Default value initialization

If you wish to return the scanner to all the factory default settings, scan the barcode above.

Note: the default setting barcode has no influence on the scanning mode setting.



Firmware version list

If you wish to display the firmware version, scan the barcode above.

11 Configuration alphanumeric entry barcode



To finish parameter setting, please scan the bar code below.

